

MOUNTING AND OPERATING INSTRUCTIONS



EB 5660 EN

Translation of original instructions



SAM HOME Gateway

Firmware 2.5.0



Edition February 2023

Note on these mounting and operating instructions

These mounting and operating instructions assist you in mounting and operating the device safely. The instructions are binding for handling SAMSON devices. The images shown in these instructions are for illustration purposes only. The actual product may vary.

- For the safe and proper use of these instructions, read them carefully and keep them for later reference.
- If you have any questions about these instructions, contact SAMSON's After-sales Service (aftersaleservice@samsongroup.com).



Documents relating to the device, such as the mounting and operating instructions, are available on our website at www.samsongroup.com > **Service & Support > Downloads > Documentation.**

Definition of signal words

DANGER

Hazardous situations which, if not avoided, will result in death or serious injury

WARNING

Hazardous situations which, if not avoided, could result in death or serious injury

NOTICE

Property damage message or malfunction

Note

Additional information

Tip

Recommended action

1	Safety instructions and measures	1-1
1.1	Notes on possible severe personal injury	1-3
1.2	Notes on possible property damage	1-3
2	Markings on the device	2-1
2.1	Nameplate	2-1
2.2	Firmware versions	2-1
3	Design and principle of operation	3-1
3.1	Status indication	3-1
3.2	Functions	3-4
3.3	Modbus TCP communication	3-4
3.4	Technical data	3-7
3.5	Dimensions	3-8
4	Shipment and on-site transport	4-1
4.1	Accepting the delivered goods	4-1
4.2	Removing the packaging from the gateway	4-1
4.3	Transporting the gateway	4-1
4.4	Storing the gateway	4-1
5	Installation	5-1
5.1	Installation conditions	5-1
5.2	Preparation for installation	5-1
5.3	Mounting the gateway	5-1
5.4	Electrical connection	5-4
6	Start-up	6-1
6.1	Setup for use with SAM DISTRICT ENERGY web portal	6-1
6.2	Setup for use with a Modbus TCP control system or with 55HOME or 55Pro apps (server mode)	6-3
7	Configuration with SAM Gateway Configurator tool	7-1
7.1	General	7-3
7.2	Firmware update	7-5
7.3	Debugging	7-7
7.4	Saving configuration data	7-9
7.5	Transferring the configuration data to the gateway	7-9
7.6	Configuration windows	7-10
7.6.1	LAN	7-10
7.6.2	Portal	7-12
7.6.3	Modbus	7-13

Contents

7.6.4	TCP forwarding	7-14
7.6.5	M-Bus	7-16
7.6.6	ZBD files.....	7-17
7.6.7	Relay control.....	7-18
7.6.8	Network Time Protocol (NTP).....	7-19
7.6.9	Security.....	7-20
7.6.10	Enabling on-site access to the gateway	7-21
7.6.11	Expert.....	7-22
8	Operation	8-1
8.1	LED status indication	8-1
9	Malfunctions	9-1
9.1	Troubleshooting	9-1
9.2	Emergency action	9-2
10	Servicing.....	10-1
11	Decommissioning	11-1
12	Removal	12-1
13	Repairs	13-1
13.1	Returning devices to SAMSON	13-1
14	Disposal.....	14-1
15	Certificates.....	15-1
16	Annex.....	16-1
16.1	Accessories	16-1
16.2	After-sales service	16-1

1 Safety instructions and measures

Intended use

The SAM HOME Gateway allows wired communication (Ethernet) to the SAM DISTRICT ENERGY web portal.

The gateway is designed to operate under exactly defined conditions (e.g. supply voltage, temperature). Therefore, operators must ensure that the device is only used in applications where the operating conditions are within the limits defined by the technical data.

SAMSON does not assume any liability for damage resulting from the failure to use the device for its intended purpose or for damage caused by external forces or any other external factors.

→ Refer to the technical data for limits and fields of application as well as possible uses.

Reasonably foreseeable misuse

The SAM HOME Gateway is not suitable for the following applications:

- Use outside the limits defined by the technical data

Furthermore, the following activities do not comply with the intended use:

- Use of non-original spare parts
- Performing maintenance activities not described in these instructions

Qualifications of operating personnel

The device must be mounted, started up and serviced by fully trained and qualified personnel only; the accepted industry codes and practices must be observed. According to these mounting and operating instructions, trained personnel refers to individuals who are able to judge the work they are assigned to and recognize possible hazards due to their specialized training, their knowledge and experience as well as their knowledge of the applicable standards.

Revisions and other modifications

Revisions, conversions or other modifications of the product are not authorized by SAMSON. They are performed at the user's own risk and may lead to safety hazards, for example. Furthermore, the product may no longer meet the requirements for its intended use. Use of the device is no longer permitted in this case.

Safety instructions and measures

Warning against residual hazards

To avoid personal injury or property damage, operators and operating personnel must prevent hazards that could be caused by the device by taking appropriate precautions. Plant operators and operating personnel must observe the hazard statements, warnings and caution notes in these mounting and operating instructions.

Responsibilities of the operator

Operators are responsible for proper use and compliance with the safety regulations. Operators are obliged to provide these mounting and operating instructions to the operating personnel and to instruct them in proper operation. Furthermore, operators must ensure that operating personnel or third parties are not exposed to any danger.

Responsibilities of operating personnel

Operating personnel must read and understand these mounting and operating instructions as well as the specified hazard statements, warnings and caution notes. Furthermore, operating personnel must be familiar with the applicable health, safety and accident prevention regulations and comply with them.

Referenced standards, directives and regulations

Devices with a CE marking fulfill the requirements of the Directives 2014/30/EU, 2014/35/EU and 2011/65/EU. This declaration of conformity is included in the 'Certificates' section.

Referenced documentation

The following documents apply in addition to these mounting and operating instructions:

- Mounting and operating instructions for connected components, e.g. heating controllers of the TROVIS 5500 Automation System
- Operating instructions for SAMSON's SAM DISTRICT ENERGY web portal ► EB 6901

1.1 Notes on possible severe personal injury

DANGER

Risk of fatal injury due to electric shock.

The SAM HOME Gateway is designed for use in low-voltage installations. Electrical connection of the device involves potential hazards.

- Observe the relevant electrotechnical regulations of the country of use as well as the regulations of the local power suppliers.
- Only allow trained and experienced personnel to perform the work.
- Before electrical connection, disconnect the supply voltage and protect it against unintentional reconnection.
- Only use power interruption devices that can be protected against unintentional reconnection of the power supply.

1.2 Notes on possible property damage

NOTICE

Unauthorized repair work will damage the SAM HOME Gateway.

- Do not attempt to repair the gateway yourself.
- Send the defective device to SAMSON.

2 Markings on the device

2.1 Nameplate

The nameplate shown was up to date at the time of publication of this document. The nameplate on the device may differ from the one shown.

The nameplate is located on the right side of the SAM HOME Gateway (viewed from the front).

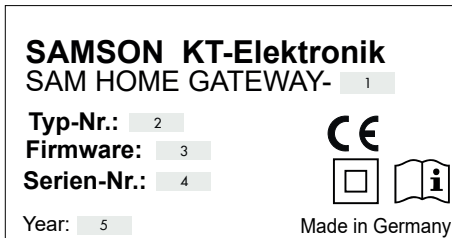

- 1 Hardware version
- 2 Type number
- 3 Firmware version (in the delivered state)
- 4 Serial number
- 5 Date of manufacture

2.2 Firmware versions

Firmware revisions	
Old	New
-	1.36
	Support and connection to SAM DISTRICT ENERGY web portal
	Data logging of status values in the integrated gateway memory
1.36	1.38
	Client/server automatic process adapted to LAN interface

Firmware revisions	
Old	New
1.38	1.9.0
	Boot loader redesigned and revised Note: → On updating the firmware version 1.38 to the next firmware version 2.x.x, the intermediate firmware version 1.9.0 (boot loader) must also be uploaded.
1.9.0	2.0.0
	Function for meter bus files (ZDB) implemented
	Login to the SAM Gateway Configurator tool over SAM DISTRICT ENERGY
	Data logger in the gateway saves more status values.
2.0.0	2.0.3
	Processing of more Modbus RTU devices connected to a gateway
2.0.3	2.0.6
	Constant measurement of the received signal strength as ASU (Arbitrary Strength Unit) also for Internet connection or during connection to the SAM DISTRICT ENERGY web portal
2.0.6	2.4.0
	New function for Modbus TCP forwarding implemented. It enables communication with devices connected to the gateway using Modbus TCP and/or TCP/IP communication (SAM DISTRICT ENERGY).
2.4.0	2.4.1
	Function for meter bus files (ZDB) improved
2.4.1	2.5.0
	NOTICE: The SAM Gateway Configurator tool (firmware version 2.4.0) is required.
	New function to support data types (input register and discrete inputs)
	New encryption protocol (TLS 1.3) for access to the SAM DISTRICT ENERGY web portal
	Improved push mode with the SAM DISTRICT ENERGY web portal

3 Design and principle of operation

The SAM HOME Gateway allows wired communication (Ethernet) with energy or utility meters, heating controllers and universal Modbus RTU devices within a network connected to the SAM DISTRICT ENERGY web portal (over an Internet connection or a Modbus TCP client). See Fig. 3-1.

The main functions of the SAM HOME Gateway are:

- Connection of TROVIS controllers to SAM DISTRICT ENERGY: analysis, management, optimization of customer systems
- Remote polling of meters with an M-Bus interface (heat, electricity, water, gas)
- Remote maintenance and visualization of SAMSON TROVIS 5573, 5576, 5578 and 5579 Controllers as well as other devices with a Modbus RTU interface
- Alarm logging (digital inputs, sensor input)
- Remote switch (floating relay output)
- Potentiometers (0 to 10 V or PWM)

3.1 Status indication

The SAM HOME Gateway has LEDs to indicate the operating and communication state of the gateway. The operating states of the gateway are indicated by LEDs during start-up and servicing.

Generally, a red LED indicates errors, whereas blinking LEDs indicate restricted functioning and constantly illuminated green or yellow LEDs indicate that the gateway is functioning properly (see Table 3-1).

Design and principle of operation

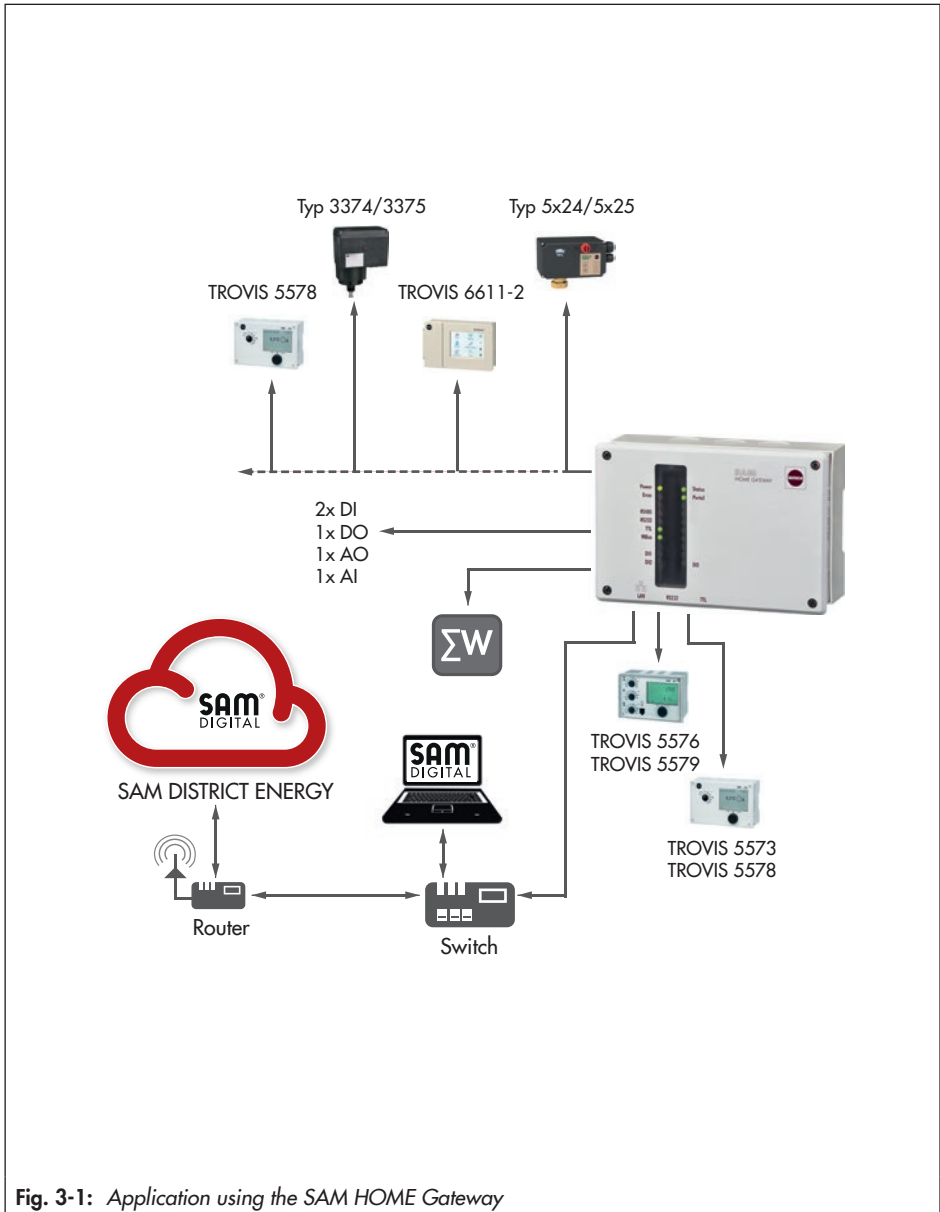

Fig. 3-1: Application using the SAM HOME Gateway

Table 3-1: LEDs and their meaning

LED name	LED state	Meaning
Power (green)	ON	Device is switched on
	OFF	Device is switched off
	Blinks very quickly	Boot loader: firmware programming
Status (yellow)	Blinking	Modbus RTU in turbo mode
Error (red)	Blinks 1x	Communication error – controller (RS-232, RS-485, TTL)
	Blinks 8x	Meter bus communication error
	Blinks 9x	M-Bus meter has generated an error
	Blinks 10x	Connection to web portal not possible
	Blinks 11x	Error on executing a ZBD file
	Blinks 12x	Modbus TCP forwarding not working
	OFF	No error
Portal (green)	ON	Connection established (SAM DISTRICT ENERGY or Modbus TCP); blinks the same number of times as the number of connections
	Blinking	
	1:1 blinking	Ethernet: DHCP client active, no IP address received
RS-485	Blinking	One green and one red LED to indicate communication on the interface. The red LED indicates data are being sent by the SAM HOME Gateway and the green LED indicates that data are being received.
RS-232		
TTL		
M-Bus		
DO (green)	ON	Relay contact (DO) in closed state
	OFF	Relay contact (DO) in open state
DI (green)	ON	External contact in closed state
	OFF	External contact in open state

3.2 Functions

Revisions and new firmware versions are created to include new functions. A summary of the revisions is included in the 'Markings on the device' section.

3.3 Modbus TCP communication

Basic function

All the SAM gateways (including SAM HOME and SAM MOBILE) have a new function to forward requests over Modbus TCP in addition to the usual communication based on the request and response method from Modbus TCP to Modbus RTU.

The added function makes it possible to directly connect Modbus TCP devices to the gateway and communicate with them. This makes the following actions possible:

1. Response over internal Modbus slaves
2. Forwarding to another Modbus TCP server
3. Forwarding to Modbus RTU interfaces (UARTs) of the gateway

Modbus topology

The gateway can receive two types of TCP-based interface requests:

1. Modbus TCP server
2. SAM DISTRICT ENERGY web interface (including push mode)

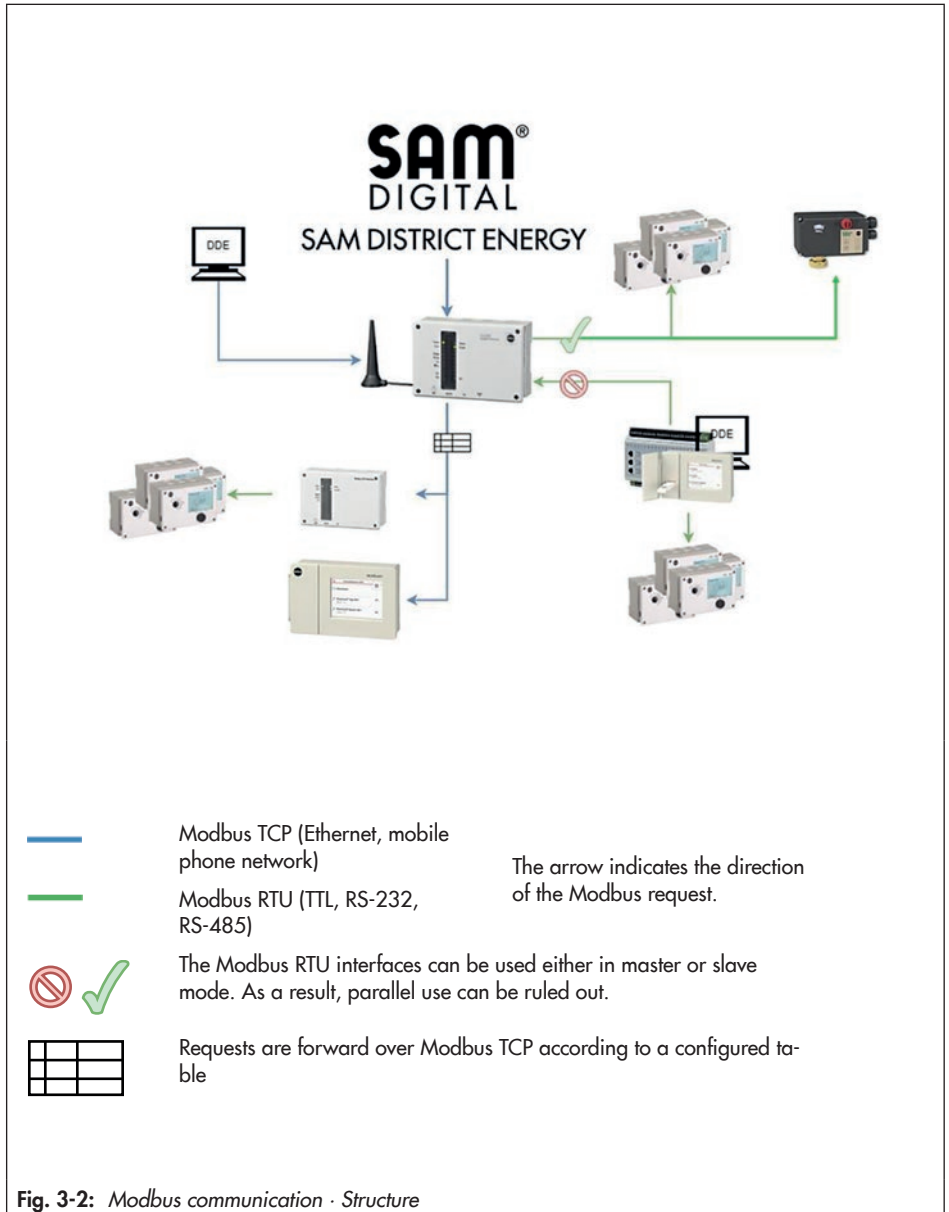

Design and principle of operation

Configuration of Modbus TCP forwarding using the SAM Gateway Configurator tool

The SAM Gateway Configurator tool (firmware version 2.3.1 and higher) in the expert mode is used for configuration. Modbus TCP devices that are accessible can be saved in the 'TCP forwarding' tab. Further information can be found in the 'Start-up' section (SAM Gateway Configurator tool - TCP forwarding).

3.4 Technical data

Table 3-2: *Technical data · Type 5660*

SAM HOME Gateway	Type 5660
LAN port (Ethernet)	IEEE 802.3, 8-pole RJ-45 port Protocol: – Modbus TCP according to MODBUS Messaging on TCP/IP Implementation Guide V1.0b (2006-10-24) – TLS V1.3
Controller interfaces	Modbus RTU protocol, 9600 or 19200 Baud and flexible baud rate; data format N1, Modbus Application Protocol Specification V1.1a (2004-06-04) 1x RS-485 Modbus interface for two-wire bus 1x TTL Modbus interface: RJ-45 port (8 pole), assignment according to TROVIS 5573/5578 Controller 1x RS-232 Modbus interface: RJ-45 port (8 pole), assignment according to TROVIS 5576/5579 Controller
M-Bus interface	Meter bus (two-wire), max. three M-Bus loads, M-Bus according to EN 1434-3 or adapted
Inputs	2 digital inputs 1 analog input 0 to 10 V or Pt1000 (–60 to +400 °C)
Outputs	1 floating relay output with varistor, max. load 250 V AC, 2 A 1 analog output 0 to 10 V or PWM, (175 Hz, 10 V, max. 10 mA)
Supply voltage	85 to 250 V, 48 to 62 Hz, max. 7 W
Permissible temperature ranges	
Ambient	0 to 50 °C
Transportation and storage	–10 to +60 °C
Degree of protection	IP 40 according to IEC 60529
Class of protection	II according to EN 61140
Degree of contamination	2 according to EN 60730
Overvoltage category	II according to EN 60730
Test standard	EN 60730, EN 60950, EN 61000-6-1, EN 61000-6-3, RED Directive 2014/53/EU, EN 301489, EN 300220
Conformity	CE
Material	PA (base, cover, housing), PA (window)

3.5 Dimensions

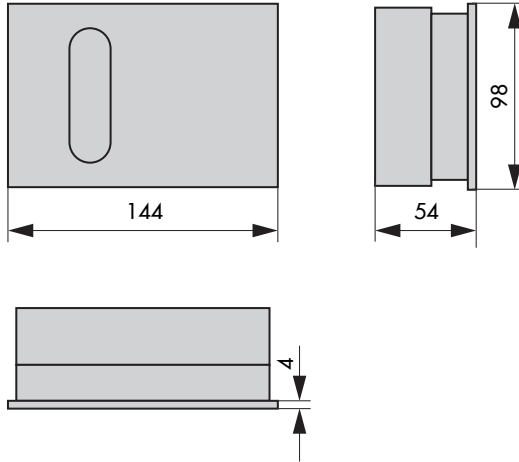

Panel cut-out 138 x 92

Fig. 3-1: Dimensions in mm · SAM HOME Gateway

4 Shipment and on-site transport

The work described in this section is only to be performed by personnel appropriately qualified to carry out such tasks.

4.1 Accepting the delivered goods

After receiving the shipment, proceed as follows:

1. Compare the shipment received with the delivery note.
2. Check the shipment for transportation damage. Report any damage to SAMSON and the forwarding agent (refer to delivery note).

4.2 Removing the packaging from the gateway

ⓘ NOTICE

Risk of device damage due to foreign particles entering it.

→ Do not remove the packaging and protective films until immediately before mounting.

1. Remove the packaging from the device.
2. Check scope of delivery (see Fig. 4-1).
3. Dispose of the packaging in accordance with the valid regulations.

- | | |
|----|---|
| 1x | Type 5660 SAM HOME Gateway |
| 1x | Document IP 5660
(Important Product Information) |
| 1x | RJ-45 cable, 8-pole |
| 1x | Network cable (LAN) |

Fig. 4-1: Scope of delivery

4.3 Transporting the gateway

- Protect the device against external influences (e.g. impact).
- Protect the device against moisture and dirt.
- Observe the permissible transportation temperature of -10 to $+60$ °C.

4.4 Storing the gateway

ⓘ NOTICE

Risk of device damage due to improper storage.

- Observe the storage instructions.
- Avoid long storage times.
- Contact SAMSON in case of different storage conditions or longer storage times.

i Note

We recommend to regularly check the gateway and the prevailing storage conditions during long storage periods.

Shipment and on-site transport

Storage instructions

- Protect the device against external influences (e.g. impact).
- Protect the device against moisture and dirt.
- Make sure that the ambient air is free of acids or other corrosive media.
- Observe the permissible storage temperature from -10 to $+60$ °C.
- Do not place any objects on the device.

5 Installation

The work described in this section is only to be performed by personnel appropriately qualified to carry out such tasks.

5.1 Installation conditions

Work position

The work position for the gateway is the front view onto the operating controls on the gateway seen from the position of operating personnel.

Operators must ensure that, after installation of the gateway, the operating personnel can perform all necessary work safely and easily access the device from the work position.

5.2 Preparation for installation

Before installation, make sure the following conditions are met:

- The gateway is not damaged.

Proceed as follows:

- ➔ Lay out the necessary material and tools to have them ready during installation.

5.3 Mounting the gateway

The gateway is suitable for panel, wall and rail mounting.

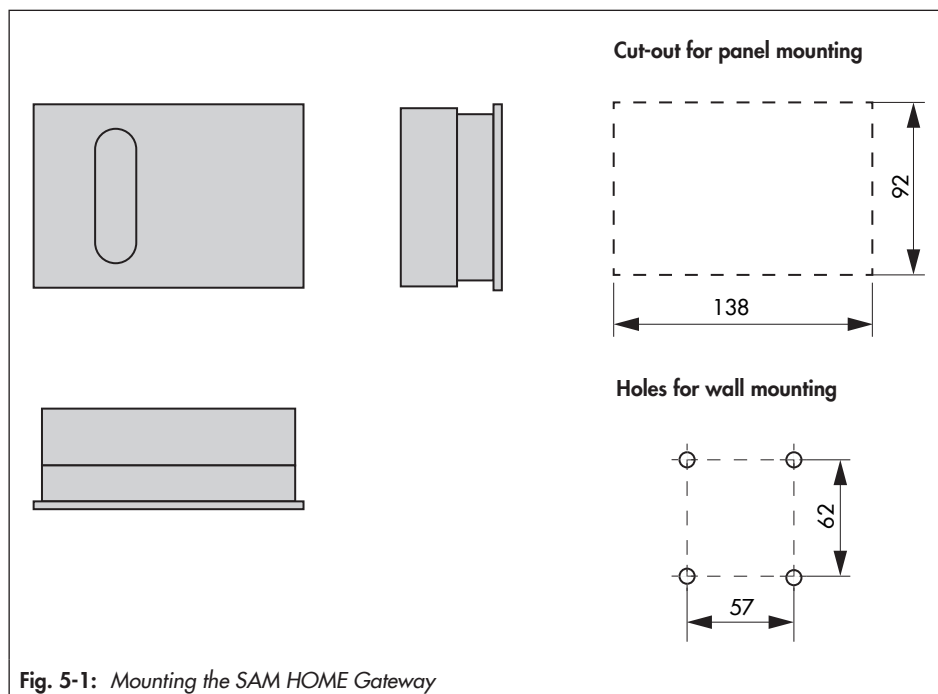

Panel mounting

1. Undo the screws on the front cover.
2. Separate the gateway from the base.
3. Make panel cut-out with the dimensions 138 x 92 mm (W x H).
4. Push the base through the panel cut-out.
5. Connect the wiring at the base as described in the 'Electrical connection' section.
6. Place the gateway onto the base.
7. Fasten the screws on the front cover.

Rail mounting

1. Fasten the spring-loaded hook at the bottom of the top hat rail.
2. Slightly push the gateway upwards and pull the top hooks over the top hat rail.
3. Undo the screws on the front cover.
4. Separate the gateway from the base.
5. Connect the wiring at the base as described in the 'Electrical connection' section.
6. Place the gateway onto the base.
7. Fasten the screws on the front cover.

Wall mounting

1. Undo the screws on the front cover.
2. Separate the gateway from the base.
3. If necessary, drill holes with the specified dimensions in the appropriate places (see Fig. 5-1). Fasten the base with four screws.
4. Connect the wiring at the base as described in the 'Electrical connection' section.
5. Place the gateway onto the base.
6. Fasten the screws on the front cover.

5.4 Electrical connection

⚠ DANGER

Risk of fatal injury due to electric shock.

The SAM HOME Gateway is designed for use in low-voltage installations. Electrical connection of the device involves potential hazards.

- *Observe the relevant electrotechnical regulations of the country of use as well as the regulations of the local power suppliers.*
 - *Only allow trained and experienced personnel to perform the work.*
 - *Before electrical connection, disconnect the supply voltage and protect it against unintentional reconnection.*
 - *Only use power interruption devices that can be protected against unintentional reconnection of the power supply.*
-

Notes on electric wiring

- Refer to the wiring diagram (see Fig. 5-1).
- Install the 230 V power supply lines and the signal lines separately.
To increase immunity, keep a minimum distance of 10 cm between the lines. Make sure the minimum distance is also kept when the lines are installed in a cabinet.
- On connecting the wiring to the terminals, make sure that all accessible parts are insulated.
- Inductances in the control cabinet, e.g. contactor coils, must be equipped with suitable interference suppressors (RC elements).
- Control cabinet elements with high field strength, e.g. transformers or frequency converters, must be shielded with separators providing a good ground connection.

Overvoltage protection

- If bus lines are installed outside buildings or over large distances, make sure appropriate surge or overvoltage protection measures are taken.
- Only use shielding that has an electric current conducting capacity and is grounded at both sides to shield the bus lines.
- Install surge diverters at the entry of the control cabinet.

The terminal compartment is located in the base of the gateway. To feed through cables, break through the holes in the marked locations at the top or bottom at the base housing and fit grommets or suitable cable glands. Ensure that the cables are not subject to torsion or bending by taking suitable precautions before inserting the cable.

⚠ DANGER

Risk of fatal injury as a result of failing to observe the permissible touch voltage.

Separation of the circuits is absolutely essential when SELV equipment is connected to terminal 21 as this equipment has a different intended use of the supply voltage than specified in the technical data (230 V AC).

The creepage and clearance present in the base and gateway do not guarantee the required dielectric strength and the safe separation of the 230 V supply voltage and the other circuits.

- ➔ Take appropriate safety precautions (e.g. by using coupling relays for the control of electric actuators operated with 24 V or for ELV fault signaling contacts).
- ➔ Only connect 230 V equipment.

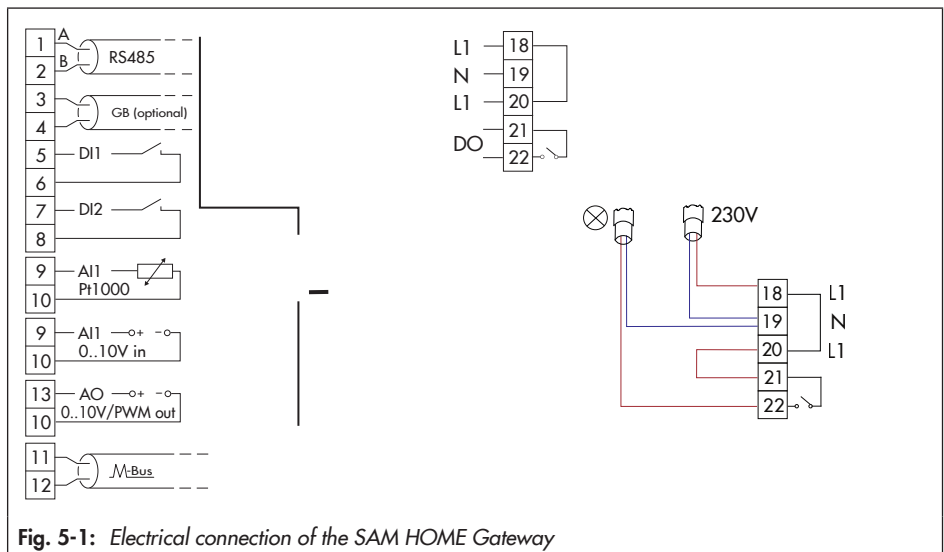

Fig. 5-1: Electrical connection of the SAM HOME Gateway

i Note

The terminals 6, 8 and 10 of the analog input, analog output and the binary inputs are connected to each other as reference potential.

Installation

Supply voltage

→ Connect the supply voltage to the terminals 18 and 19 in the base of the gateway.

Controller connection RS-232

One single SAMSON TROVIS 5576 or 5579 Controller, or alternatively another device that has an RS-232 interface, can be connected to the RS-232 port of the SAM HOME Gateway. Do not activate the modem operation function of a connected controller. **Exception:** fault alarm of a separately connected controller with the modem/controller setting (TAP-SMS).

Controller connection TTL

The TTL port is used to connect a single SAMSON TROVIS 5573 or 5578 Controller, a SAMSON KT-ELEKTRONIK SOL3 or WPR3 Controller or equivalent device. The controller is connected with an 8-pole RJ-45 cable (max. cable length: 100 cm) directly to the gateway.

Controller connection over RS-485 bus

One or more controllers or Modbus RTU devices can be connected to the terminals 1 and 2 (RS-485) of the gateway. In this case, the controllers and devices must have an RS-485-interface (two-wire version) or be fitted with a corresponding converter.

i Note

*The connection of more than 10 controllers to the RS-485 bus may cause the monthly data allowance limit to be exceeded. **Additional costs may be incurred.** Your SAMSON point of contact can help you in such cases.*

Examples:

- Converter for TROVIS 5573/5578: iCon485 (8812-2002)
- Converter for TROVIS 5576/5579: cable converter (1400-8800)

This allows up to 40 controllers or Modbus RTU devices to be connected to a single SAM HOME Gateway. For the sake of quick access to controller data, we recommend not to make full use of this specification. In such cases, we recommend using several gateways.

Various RS-485 devices can be connected as part of an RS-485 network to the two-pole terminal. RS-485 network rules concerning stub lines, bus termination and bus bias voltage must be observed in this case.

Devices with RS-485 interface in four-wire versions can be used. In this case, we recommend using the CoRe02 Universal Bus Unit (article no. 11996, order no. 1402-1433). When bus hubs (1400-7140) are used in place of the CoRe02 universal bus unit to connect devices with RS-485 interface in four-wire versions, the T_A wire must be jumpered to the R_A wire and the T_B wire jumpered to the R_B wire.

Digital output (relay)

The digital output (relay) is a floating switching contact at terminals 21 and 22. Small loads can be switched using this switching output. It can also be connected to a digital input of another device.

- ➔ Apply a switching voltage (e.g. 230 V AC) to terminal 21 (e.g. using a jumper from terminal 20 (L1)).
- ➔ Observe the permissible load of the relay specified in the technical data. A contactor must be installed in the circuit for higher loads.

M-Bus interface (meter bus)

Up to three heat, water, gas or electricity meters with an M-Bus interface can be connected at terminals 11 and 12 (M-Bus). The meter data (meter readings, momentary capacity, flow rate etc.) are available over Modbus TCP.

Analog input ¹⁾

The analog input at the terminals 9 (AI1) and 10 of the device is used for direct connection of 0 to 10 V sensors or Pt1000 sensors. Select the analog input type in the SAM Gateway Configurator tool (see the 'Start-up' section).

– 0 to 10 V

If a (positive) DC voltage between 0 and 10 V is applied to terminal AI1 to act in the opposite direction to the COM terminal, the measured value can be read remotely using the SAM HOME Gateway. It is used to read a signal of another device or a 0 to 10 V sensor.

– Pt1000

If a Pt1000 sensor is connected to AI1 and COM terminals, the SAM HOME Gateway is able to read the temperature at the sensor and make this value available for data remote polling.

Installation

Digital inputs ¹⁾

Both inputs DI1 (terminal 5) and DI2 (terminal 7) can be used to register the state of two floating contacts (e.g. switches or relays of another device). A voltage input is not permitted.

Analog output ¹⁾

The analog output at the terminals 13 (AO1) and 10 (COM) of the device is used for direct connection of control inputs for 0 to 10 V signals or a PWM signal. It can be used for the remote control of actuators or pumps.

Network connection (LAN)

The LAN port of the SAM HOME Gateway allows connection to a network. It can be connected using an 8-pole patch cable to a network switch, hub or Internet router. It is also possible to directly connect a computer.

The interface is also used for onsite configuration using the SAM Gateway Configurator tool (see the 'Start-up' section).

6 Start-up

The SAM Gateway Configurator tool (see the 'Configuration with SAM Gateway Configurator tool' section) installed on a computer as well as a patch cable are required to start up the SAM HOME Gateway.

i Note

In the delivered state, the SAM HOME Gateway is configured for communication over the Ethernet interface including an automatic function to switch between DHCP client and DHCP server. The DHCP client function remains active for around one minute after the device is switched on. If the SAM HOME Gateway does not receive an IP address from a DHCP server during this period, the device starts to function as a DHCP server with the configured IP address (default setting: 192.168.55.2).

6.1 Setup for use with SAM DISTRICT ENERGY web portal

How to proceed:

- ➔ Connect the SAM HOME Gateway to the supply voltage.

The power LED is illuminated when the supply voltage is connected.

LED	Status
Power	ON
Portal	Any
LAN port	Blinking

- ➔ Use a patch cable to connect the computer to the SAM HOME Gateway (LAN port).
- ➔ Open the SAM Gateway Configurator tool installed on the computer. Perform a scan and select the gateway you require by double-clicking it.
- ➔ Configure the following settings in the indicated order:
 - IP address (DHCP/static IP)
 - M-Bus configuration
 - Modbus settings
 - Optionally: error alarms

After saving the configuration settings, the SAM HOME Gateway automatically restarts.

- ➔ Disconnect the computer from the SAM HOME Gateway.

Start-up

- Use a network cable to connect the SAM HOME Gateway to the Internet.

The SAM HOME Gateway automatically attempts to establish connection to the SAM DISTRICT ENERGY portal. This process may take up to two minutes.

LED	Status
Power	ON
Portal	ON (blinking)

- Log in to the SAM DISTRICT ENERGY web portal using your personal login data (▶ EB 6901).
- Register the SAM HOME Gateway using the MAC address of the device (visible on the housing, starting with 00:E0:99:Fx:xx:xx).
For reasons of data security, the device must be registered in the web portal within six hours after the device has been started.
Restarting the gateway resets this time and allows the device to be registered after a timeout.

i Note

Settings, such as the utility meter settings (primary address, readout type and cycle), can be configured directly in SAM DISTRICT ENERGY (▶ EB 6901). Additional settings (including settings in the expert mode) and the debugging function are performed using the SAM Gateway Configurator tool. These settings can be made on a computer and transferred afterwards to the device.

6.2 Setup for use with a Modbus TCP control system or with 55HOME or 55Pro apps (server mode)

i Note

A DynDNS account is required to use the SAM HOME Gateway in server mode. This enables the SAM HOME Gateway to be accessed on the Internet. The DynDNS account must be set up by the user (not included in the scope of services provided by SAMSON). **Additional costs may be incurred.**

The DynDNS settings are manufacturer-specific. Your point of contact in charge of IT in your organization can help you in such cases.

In applications other than the SAM DISTRICT ENERGY web portal, the SAM HOME Gateway functions as a server, while the control software or smartphone app functions as a client. In this case, the SAM HOME Gateway must operate with an IP address that can be accessed by the clients. Activate and set a port forwarding in the router (Modbus TCP port: 502).

For dynamic IP address assignment, the IP address assigned to the SAM HOME Gateway must be public on the Internet and a domain name service (DNS) must be configured in the Internet router used on site for the SAM HOME Gateway.

How to proceed:

- ➔ Connect the SAM HOME Gateway to the supply voltage.

The power LED is illuminated when the supply voltage is connected.

LED	Status
Power	ON
Portal	Any
LAN port	Blinking

- ➔ Use a patch cable to connect the computer to the SAM HOME Gateway (LAN port).
- ➔ Open the SAM Gateway Configurator tool installed on the computer. Perform a scan and select the gateway you require by double-clicking it.
- ➔ Configure the following settings in the indicated order:
 - IP address (DHCP/static IP)
 - M-Bus configuration
 - Modbus settings
 - Optionally: fault alarms

After saving the configuration settings, the SAM HOME Gateway automatically re-starts.

Start-up

- Disconnect the computer from the SAM HOME Gateway.
- Use a network cable to connect the SAM HOME Gateway to the Internet.
- Connect the SAM HOME Gateway to the corresponding field devices (controller, energy meter) and send a request over the Modbus TCP client (building automation system).
- Log in to the SAM DISTRICT ENERGY web portal using your personal login data (▶ EB 6901).

LED	Status
Power	ON
Portal	ON

7 Configuration with SAM Gateway Configurator tool

The basic configuration is performed using the **SAM Gateway Configurator** tool. The configuration software tool runs under Microsoft Windows® 7, Windows® 8 and Windows® 10. It is installed using the provided setup program. **Microsoft .NET Framework 4** is required to install the SAM Gateway Configurator correctly.

In addition to configuration, the **SAM Gateway Configurator** can perform firmware updates and analyze the gateway operations (Debug-Viewer).



Tip

The SAM HOME Gateway is delivered to work with a default password. We recommend changing the password on start-up.



Note

The SAM Gateway Configurator tool can be downloaded from our website

▶ www.samsongroup.com > Products & Applications > Product selector > Automation Systems > SAM HOME Gateway.

Configuration with SAM Gateway Configurator tool

Firmware versions

Firmware revisions	
Old	New
1.7.3	1.8.0
	Supports new gateway generation (SAM HOME Gateway)
	Modbus RTU functions extended in expert mode
1.8.0	2.0.3
	UDP used for firmware updates
	Visible fields and tabs adapted for various firmware and gateway versions
2.0.3	2.1.2
	Reading (Major.Minor.Patch) in the Configurator tool showing the gateway firmware version
2.1.2	2.1.3
	Firmware transmission using UDP improved
2.1.3	2.3.1
	Separate readings (columns) for Modbus TCP and web portal connections
	Separate configuration possible for the Modbus RTU function (slave) and the Modbus TCP forwarding (firmware version 2.4.0 required)
2.3.1	2.3.3
	TCP configuration functions (remote updating and access) changed
2.3.3	2.4.0
	Supports SAM MOBILE Gateway/SAM HOME Gateway devices (firmware version 2.5.0 and higher)
	RegComTCP with new configuration structure (version 2, firmware version 1.2.1 and higher) for TROVIS 5578-E (5578-1113 version)
2.4.0	2.4.1
	Improved password configuration

7.1 General

The 'Scan' button can be used to search the network for Ethernet devices belonging to the SAM gateway product group that are available and for the internal Ethernet interface in the TROVIS 5578-E Heating Controller.

UDP broadcast telegrams are used and prioritized for the search and configuration. This is necessary to allow those devices to respond that are not configured for the network subnet used by the computer. 'DHCP server' is activated by default in the SAM HOME Gateway. The gateway waits approx. 60 s after the voltage supply is connected before it assigns an IP address. If this is not the case, the device assigns an IP address for itself and any connected devices (e.g. laptop). This ensures that the gateway and laptop can communicate.

The screenshot shows the 'SAM Gateway Konfigurator' application window. At the top, there are menu options: 'Datei', 'Aktion', 'Einstellungen', and 'Hilfe'. Below the menu is a 'Scannen' button. The main area contains a table with the following columns: 'Modell', 'Name', 'SerienNr.', 'IP-Adresse', 'MAC-Adresse', 'Firmware', 'Modbus...', and 'Portaltve...'. The table lists 18 discovered devices with their respective details.

Modell	Name	SerienNr.	IP-Adresse	MAC-Adresse	Firmware	Modbus...	Portaltve...
5014	...	17490	192.168.3.7 (UDP)	00:E0:99:FF:...	2.4	0	Nein
5014	...	33348	192.168.55.99 (UDP)	00:E0:99:FF:...	2.4	0	Nein
5014 (I)	...	1015	192.168.3.47 (UDP)	00:E0:99:FF:...	2.4	5	Nein
5014	...	2737	192.168.1.120 (UDP, TCP)	00:E0:99:FF:...	2.4	0	Nein
5014	...	3818	192.168.55.90 (UDP)	00:E0:99:FF:...	2.3.91	0	Ja
5014	...	45052	192.168.2.179 (UDP)	00:E0:99:FF:...	2.3.1	0	--
5015	...	3748	192.168.1.206 (UDP)	00:E0:99:FF:...	2.0	0	--
5015	...	3432	192.168.2.180 (UDP)	00:E0:99:FF:...	2.3.2	1	--
5015 (I)	...	4488	192.168.2.252 (UDP)	00:E0:99:FF:...	2.3	5	--
5015	...	23	192.168.55.95 (UDP)	00:E0:99:FF:...	1.29	0	--
5015	...	4486	192.168.2.250 (UDP)	00:E0:99:FF:...	2.3.1	3	--
5015	...	4491	192.168.2.253 (UDP)	00:E0:99:FF:...	2.3.1	2	--
5015	...	4490	192.168.2.254 (UDP)	00:E0:99:FF:...	2.3	3	--
5017	...	54565	192.168.3.43 (UDP)	00:E0:99:FF:...	1.0	0	--
5017	...	2924	192.168.3.14 (UDP)	00:E0:99:FF:...	1.1	0	--
5018	...	48789	192.168.2.200 (UDP)	00:E0:99:FF:...	1.1	0	--
5018	...	2907	192.168.3.15 (UDP)	00:E0:99:FF:...	1.1	0	--

Configuration with SAM Gateway Configurator tool

Device overview

After scanning, all the available devices are shown with the following information:

Column	Description
Model	Device model number
Name	Any name (max. 16 characters) can be assigned to make it easier to find the device
Serial number	Internal serial number of the device
IP address	IP address assigned by the DHCP server or at the time when it was scanned
MAC address	Physical address of the Ethernet interface The internationally unique address is printed on the device housing.
Firmware version	Current software version of the device
Modbus TCP connections	Number of active Modbus TCP/IP connections (incoming and outgoing)
Connection to web portal	The connection to the web portal indicates whether the device is currently connected to the web portal (SAM DISTRICT ENERGY). (Yes/No)

i Note

Information on the connection to the web portal is not processed in the firmware version 2.4.0 and lower. '--' is shown in the column. In this case, a connection to the web portal is counted by the connection counter and displayed in the 'Modbus TCP connections' column.

7.2 Firmware update

To start an update of the SAM HOME/SAM MOBILE Gateway:

→ Right-click the device you want to update.

Alternatively:

→ Click 'Update'.

The following conditions must be met for the update to work:

1. New firmware (*.b66 or *.B56 file)
2. An FTP protocol (firmware version 2.0 and higher) or a proprietary communication is used between the software and the device (all other devices). If a firewall is installed (e.g. Windows®), it must let all protocol telegrams through.
3. The gateway is addressed over its IP address. In this case, the correct IP address and sub-net mask must be entered.

i Note

A valid gateway configuration is essential before an update is performed to ensure that the gateway does not change to the error mode during the update process. Otherwise, the errors may lead to the connection being interrupted. In this case, the update will fail.

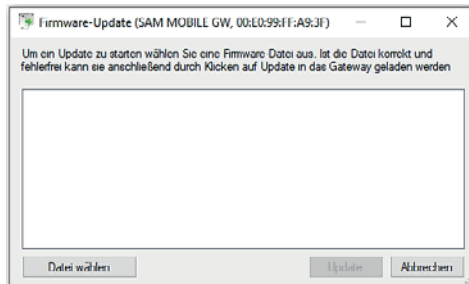

Configuration with SAM Gateway Configurator tool

Selecting the files and starting the update

→ Click 'Select file'.

The required firmware version is uploaded from the computer to the program.

→ Click the 'Update' button to confirm.

You are prompted to enter the login details. This is the default setting provided the setting in the 'Security' tab has not been changed.

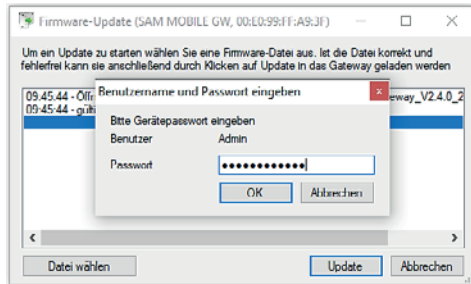

The firmware update starts. The current status is indicated in the progress bar (bottom left).

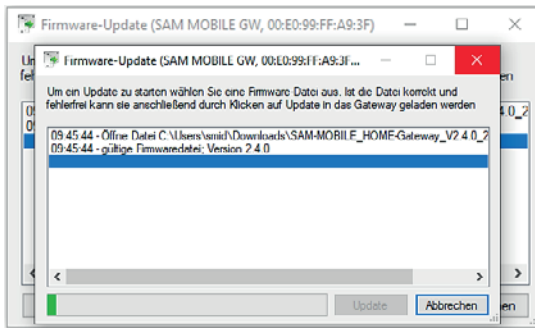

The firmware update is completed.

The output window logs the actions and errors that occurred during the firmware update.

→ Close the firmware update window.

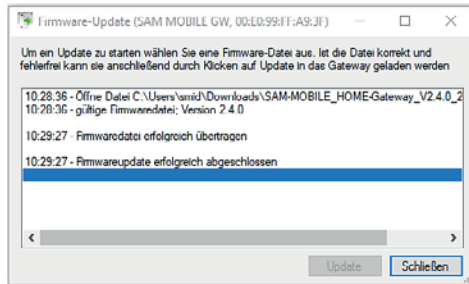

7.3 Debugging

The debugging details contain information to check the operations of the gateway. They also facilitate troubleshooting in the installed system. It includes any requests and responses over Modbus TCP and Modbus RTU as well as information on the Internet and web portal connection.

- ➔ Select the required device.
- ➔ Select 'Debug' from the 'Action' menu to open the debug window for the selected device.

Alternatively:

- ➔ Right-click on the device and select the menu item.

i Note

The function is protected by the default or custom password.

Selecting debug information (start, monitor or stop logging)

You can select information that you want to include in the list from the drop-down menu. Click the 'Start' button to start the process to collect debug information.

Configuration with SAM Gateway Configurator tool

Nr.	Zeit	Richtung	Funktion	Beschreibung	Daten
116	12:19:00,073		Portal Info	Verbinde mit 172.19.2.103:443	
117	12:19:01,941		Portal Info	INFO: RTCS: Systemzeit aktualisiert f...	
119	12:19:05,767	TCP <-- 172.19.2.103:443	Portal Daten empfangen	nach Entschlüsselung	00 01 00 10 00 01
120	12:19:05,767	TCP <-- 172.19.2.103:443	Portal Daten empfangen	nach Entschlüsselung	01
121	12:19:05,767		Portal Info	Verbindung hergestellt	
122	12:19:05,767		Verbindung 0 auf Port 443	Portal	
123	12:19:05,989	TCP <-- 172.19.2.103:443	Portal Daten empfangen	nach Entschlüsselung	00 04 00 20 00 09
124	12:19:05,990		Portal Info	Neues Telegramm vom Typ 20 (Leng...	
125	12:19:05,990	TCP <-- 172.19.2.103:443	Portal Daten empfangen	nach Entschlüsselung	02 08 01
126	12:19:05,990		Portal Info	Portal Push: Reconfigure: Gruppe 2	
127	12:19:05,990	TCP <-- 172.19.2.103:443	Portal Daten empfangen	nach Entschlüsselung	1e 00 01
128	12:19:05,990	TCP <-- 172.19.2.103:443	Portal Daten empfangen	nach Entschlüsselung	00 92 01
129	12:19:05,990		Portal Push Betrieb	Reconfigure: Gruppe 2 aktualisiert au...	
130	12:19:05,990	TCP > 172.19.2.103:443	Portal Daten gesendet	vor Verschlüsselung	00 04 00 10 00 01 00
131	12:19:06,131	TCP <-- 172.19.2.103:443	Portal Daten empfangen	nach Entschlüsselung	00 06 00 20 00 03
132	12:19:06,131		Portal Info	Neues Telegramm vom Typ 20 (Leng...	
133	12:19:06,131	TCP <-- 172.19.2.103:443	Portal Daten empfangen	nach Entschlüsselung	03 05 00
134	12:19:06,131		Portal Info	Portal Push: Reconfigure: Gruppe 3 ...	
135	12:19:06,131		Portal Push Betrieb	Reconfigure: Gruppe 3 aktualisiert au...	

The table shows all the relevant and collected information. If you want to display all data, click the '<' button on the right of the window to open an additional bar.

Click the 'Clear' button to clear all the debug messages from the list.

Click the 'Stop' button to stop logging the debug information.

NOTICE

Function impaired while transferring debug information.

The transmission of debug information adds an extra strain on the network. A network already working at full capacity may impair the functioning of other devices.

→ Only use the function briefly for troubleshooting.

Saving debug information

Click the 'Export' button to save the listed data in a special format (*.ktc) on a computer for later analysis.

7.4 Saving configuration data

- Select the device whose configuration data you want to save.
- Select 'Save to file' from the 'Action' menu.

Alternatively:

- Right-click on the device and select the menu item.

The configuration data from the gateway are loaded. A window to enter the file name and storage location opens.

- Confirm to save.

A file (*.ktc) is saved on the computer.

i Note

The configuration data are saved and transmitted in encrypted form. For subsequent decryption, the gateway password (default or custom) must be known as the source of the file.

7.5 Transferring the configuration data to the gateway

- Select the 'Action' menu or right-click on the device to select the 'Load file' menu item.

A window to select the required configuration file (*.ktc) opens.

- Click the 'Open' button to confirm.

You are prompted to enter the authentication details for decryption.

- Enter the administrator password used for the gateway (source of the file).

After entering the correct password, a configuration window opens to allow parameters to be checked and changed, if necessary.

- Click the 'Transmit' button to confirm.

The configuration is saved in the gateway.

7.6 Configuration windows

Depending on the device type and firmware version, the configuration windows are shown with various tabs and parameter settings.

i Note

The firmware is being constantly developed further. To fully use all the functions, we recommend always to operate the device with the latest firmware. The default password to open the expert level, update the firmware and access other functions can be found in the Annex of these mounting and operating instructions.

7.6.1 LAN

The basic functions of the Ethernet port are configured in the 'LAN' tab. The gateway operates in networks that use IPv4 protocols. The gateway can work with an IP address dynamically assigned by a DHCP server. Alternatively, it can be given a static IP address and act as a DHCP server in the network.

In the delivered state, the gateway is ready configured to wait 60 s after starting as a DHCP client for an IP address to be assigned. If no IP address is assigned within this period, the DHCP server function is activated. The gateway then automatically assigns an IP address with subnet mask for itself and all connected devices (e.g. workstation).

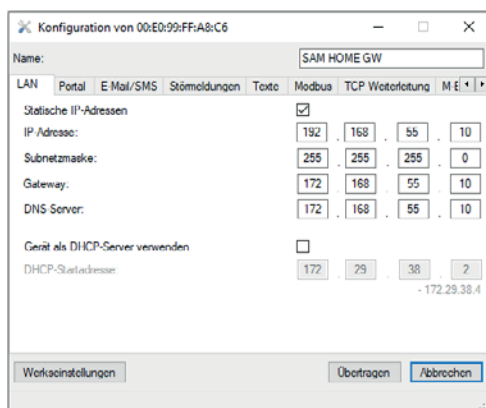

Operation with static IP addresses requires entry of IP addresses, subnet masks and gateway.

→ Contact your system administrator for these parameters.

Static IP address

- When the 'Static IP addresses' box is checked, the gateway uses a fixed IP address. If left unchecked, the IP address is assigned by a DHCP server.

DHCP server

When the 'Use device as DHCP server' box is checked, the gateway acts as a DHCP server and assigns IP addresses within a defined range to connected devices.

The address in 'DHCP start address' is the first address that the DHCP server will use when it assigns IP addresses.

7.6.2 Portal

The gateway is ready configured to automatically establish connection to the cloud-based SAM DISTRICT ENERGY and cyclically transmit data after the device has been registered in SAM DISTRICT ENERGY. There are three groups for push intervals. The 'Portal' tab allows the web portal to be activated or deactivated and the available parameters to be entered.

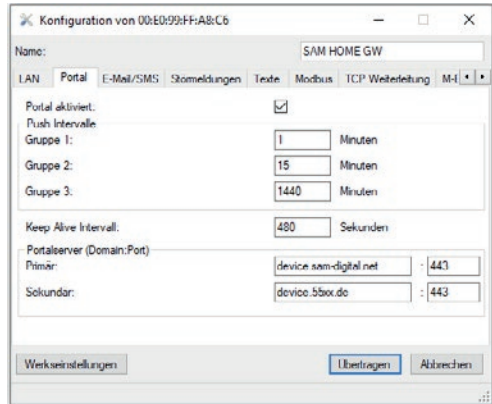

Portal activated	Activates or deactivates the web portal
Push intervals	Setting in minutes to determine how often data assigned to the group are to be sent to the web portal.
Keep alive interval	Setting in seconds to determine the minimum duration of contact to the server <div style="border: 1px solid black; padding: 5px; margin: 5px 0;">i Note <i>Push groups with smaller values do not have any function as communication is established with the server at shorter intervals.</i></div>
Portal server (expert level)	Determines the domain URL (address of the web portal's server) <div style="border: 1px solid black; padding: 5px; margin: 5px 0;">i Note <i>Characters and/or numbers can be entered to specify the domain as an IP address. Two address fields are available: The second address is used after the connection to the first URL fails. These fields are only available in the expert level.</i></div>

7.6.3 Modbus

The settings for the Modbus RTU interfaces (RS-232, RS-485 and TTL) are made in the 'Modbus' tab.

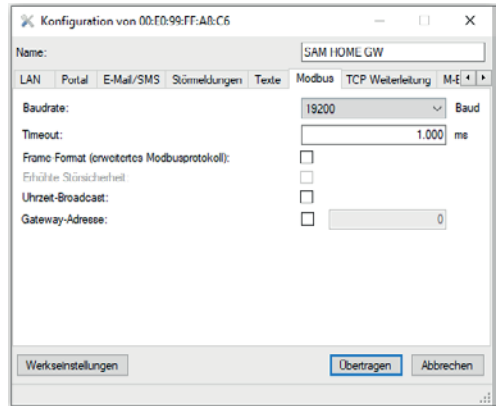

Baud rate	Transmission rate for the RS-232, RS-485 or TTL interfaces
Timeout	<p>Time in milliseconds that the gateway waits for the Modbus interfaces to respond (request/response communication) The recommended value is 1000 ms = 1 s.</p> <hr/> <p>i Note</p> <p><i>Values that are too low may lead to unwanted results. Write commands often take significantly longer than read commands.</i></p> <hr/>
Frame format	<p>Extended Modbus protocol for the data communication with Series 5500 Heating Controllers This setting accelerates communication and makes transmission more reliable.</p> <hr/> <p>i Note</p> <p><i>This function must be deactivated when other generic Modbus devices and non-TROVIS heating controllers are used.</i></p> <hr/>

Configuration with SAM Gateway Configurator tool

Time broadcast	Gateway time synchronized with connected Modbus RTU devices i Note <i>The interval is 24 hours. The devices must support the time broadcast command (45Hex) to use this function.</i>
Gateway address	Modbus address of the gateway for addressing and communication The address allows access to gateway data (e.g. utility meters connected over M-Bus) over Modbus TCP and Modbus RTU. i Note <i>A Modbus address (gateway or controller) in a communication path or a communication network must be unique.</i>

7.6.4 TCP forwarding

This function allows the forwarding of Modbus RTU requests (e.g. over Modbus TCP server, web portal, UART interface) to the configured Modbus TCP server. In the expert mode of the Configurator tool, Modbus TCP devices that can be reached (e.g. Modbus TCP gateway or a TROVIS 5578-E Controller) can be listed in the 'TCP forwarding' tab. The IP address and the corresponding station address are used for assignment.

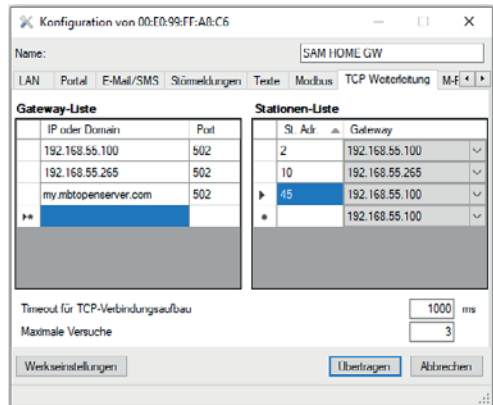

After the gateway receives a Modbus request at one of the assigned station address, the requests are forward to the correspondingly defined Modbus TCP server.

Gateway list

The gateway lists contains all the known and connected gateways which are entered manually. A maximum of 60 gateways can be linked to a gateway. Five of them can be entered as domain addresses.

IP or domain	IP address or domain address of the gateway
Port	Port number of the gateway for the Modbus TCP connection (Port: 502) Entering '0' deactivates the gateway.

Station list

The station list contains the links between the connected gateways and the internal station addresses. The corresponding gateways can be selected from a drop-down list of devices which must first be entered into the left table.

St. Adr	Internal station address The valid range is between 1 and 247. i Note <i>Station addresses must not be the same as the Modbus address of the gateway.</i>
Gateway	Specifies with which gateway the station address is to be linked
Timeout for establishing TCP communication	Maximum duration in milliseconds to establish Modbus TCP connection.
Max. attempts	Maximum number of attempts to establish communication with the gateway i Note <i>Once the entered number of attempts is reached, no new attempt is made to establish communication.</i>

7.6.5 M-Bus

It is possible to connect up to three M-Bus meters to the gateway. Go to the 'M-Bus' tab to configure this setting. The meter configuration and settings can also be performed in the SAM DISTRICT ENERGY web portal.

These meters have a unique primary address. The address is written in the product documentation of the connected meter. If the preset meter bus address is unknown, a single meter connected to the gateway can be assigned the meter bus address 254. The address 0 or 255 deactivates the communication with the respective meter.

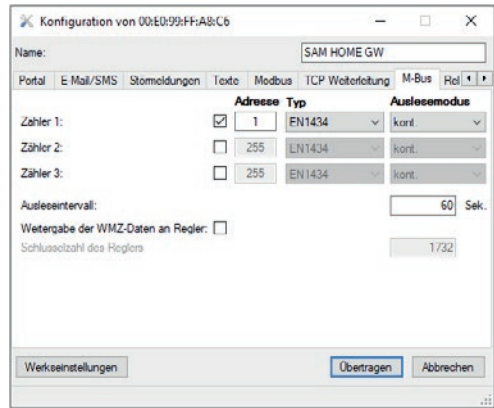

The meter type is selected according to a classification of the M-Bus properties of the various meters. In general, the default setting according to the requirements of EN 1434-3 remains unchanged. The reading mode setting depends on the supply voltage of the meter (battery/230 V) and the required refresh rate for the connection to the control system or web portal. The refresh rate for the 'Continuous' reading mode is specified in seconds. We recommend a reading mode of at least 15 minutes for battery-operated meters to ensure the batteries last until the next battery change is prescribed.

<p>Address</p>	<p>Meter address at the meter bus (primary M-Bus address)</p> <hr/> <p>i Note</p> <p><i>Meter configuration is deactivated by entering '255' as the address or unchecking the associated box.</i></p>
<p>Type</p>	<p>Type of the connected meter according to the classification of the M-Bus properties</p>
<p>Reading mode</p>	<p>The reading mode determines the polling interval at which the gateway requests meter consumption data.</p>
<p>Polling interval</p>	<p>Frequency of meter readout The frequency is specified in seconds.</p>

It is also possible to forward the meter's measured values (e.g. capacity or flow rate) to a suitable Series 5500 TROVIS Controller connected to the gateway. In this case, the corresponding function (forwarding meter data to a controller) must be activated and the controller key number entered. The meter values are then written to the corresponding holding register assigned to heating circuit 1.

7.6.6 ZBD files

An individual mapping file (ZBD) can be created and uploaded onto the gateway in cases where manufacturer-specific meter data are required and when meter data are to be read that do not belong to the standard defined meter values. The ZBD file is used for targeted polling of meter values and manufacturer-specific special values (e.g. billing date values or monthly values, meter time etc.) according to the meter bus specifications of EN 1434-3 or adapted. The function is available for SAMSON gateways and certain TROVIS heating and district heating controllers (TROVIS Series 5500).

Contact SAMSON for more detailed information.

7.6.7 Relay control

The parameters for the analog input and the associated relay are configured in this tab. The gateway's threshold switch requires information on the switching level, hysteresis and direction of action. In this case, it is configured on site at the device. The function can also be configured and set over the SAM DISTRICT ENERGY web portal.

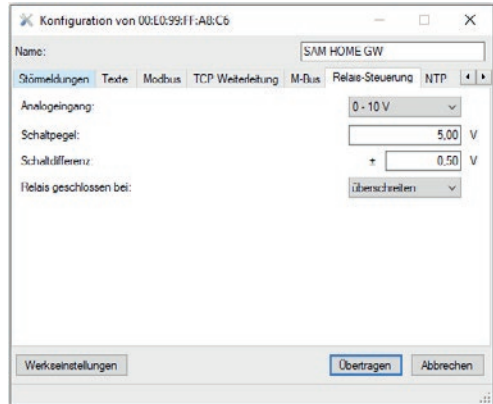

Analog input	Input signal at the analog input It can differentiate between a voltage (0 to 10 V) and a temperature from a Pt1000 sensor.
Switching level	Voltage or temperature at which the relay switches
Hysteresis	The hysteresis prevents a constant switching between active and inactive within the range of the switching level.
Relay closed when	Information on whether the relay contact closes when the switching level exceeds or falls below a certain level

7.6.8 Network Time Protocol (NTP)

The device requires the time at the place of installation for functions requiring exact times (e.g. alarms, data logging etc.). The gateway can poll this time cyclically from special servers over the standardized protocol NTP (Network Time Protocol).

i Note

The gateway supports automatic summer time switchover.

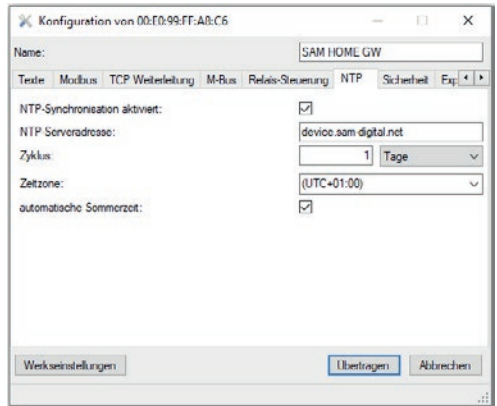

Activate NTP synchronization	Activates or deactivate this function.
Cycle	Address details of the NTP server Supports both IP addresses (e.g. 192.168.1.2) and domains (e.g. zeitf.meinserver.com).
Time zone	Determines the time zone in which the gateway is located. The server time is always specified in the UTC (Coordinated Universal Time) format. This value is corrected according to the time zone and set to the applicable local time.
Automatic summer time	Determines whether daylight saving time is implemented. i Note <i>The time is automatically changed on the last Sunday in March and on the last Sunday in October.</i>

7.6.9 Security

Access passwords of the administrator for login and firmware updates can be changed. Functions including those relevant for data security, encryption and remote access to activate and configure the device can also be changed.

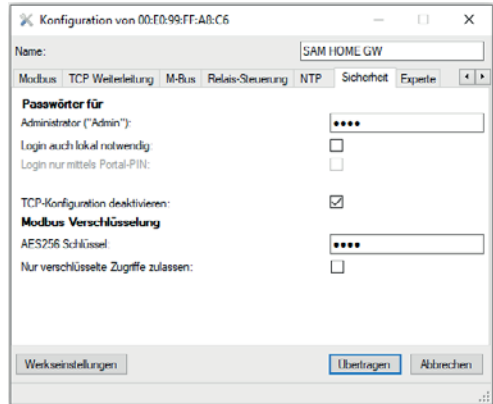

<p>Password for administrator ('admin')</p>	<p>Determines the administrator password for the device The user name is 'Admin'.</p> <hr/> <p>i Note <i>The default password is 'Kundendienst'.</i></p>
<p>Local login also required</p>	<p>Deactivates the ability to configure the device on site without a password (recommended)</p> <hr/> <p>i Note <i>Access to the gateways is no longer possible without entering the password.</i></p>

<p>Login only with portal PIN</p>	<p>Deactivates authentication with the password saved in the device (administrator password) Instead, login is only possible with a temporary PIN transferred over the SAM DIGITAL web portal.</p> <hr/> <p>i Note</p> <p><i>Access to the device might not be possible if there is no connection to the web portal (e.g. no Internet connection).</i></p>
<p>Deactivate the FTP server</p>	<p>Deactivates the FTP server.</p> <hr/> <p>i Note</p> <p><i>The FTP server is used for firmware updates, for example. An update is no longer possible if this function is deactivated.</i></p>
<p>Deactivating TCP configuration</p>	<p>Deactivates the option to address the device over the TCP protocol.</p> <hr/> <p>i Note</p> <p><i>Communication via TCP allows the configuration over a stable connection outside the subnet. Remote configuration is no longer possible if this function is deactivated.</i></p>
<p>Modbus encryption</p>	<p>When activated, only encrypted access is permitted. Access over Modbus TCP with unencrypted packages is blocked.</p>
<p>AES-256 key</p>	<p>Password entry for encrypted communication (AES 256) The length is restricted to 250 characters.</p>

7.6.10 Enabling on-site access to the gateway

A function to enable the access over a portal PIN can be activated in the 'Security' tab to prevent unwanted remote access in the field to the gateway configuration data. This function can only be used in combination with access to the SAM DISTRICT ENERGY web portal. It must be enabled in the client's account. Contact your contact person at SAMSON AG.

Configuration with SAM Gateway Configurator tool

i Note

The devices can no longer be operated if the function is activated but there is no web portal access in the client's account. A stable Internet connection is required.

After activation, the device-specific six-digit PIN can be created in the corresponding client's account and sent to the gateway. Configuration and on-site access to the gateway is only possible after entering the PIN.

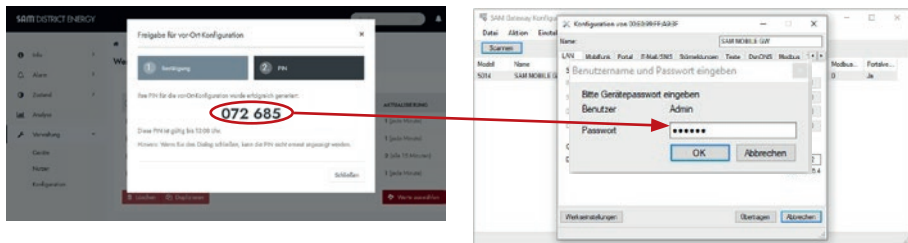

i Note

The PIN becomes invalid after three hours. A new PIN must be created and sent.

7.6.11 Expert

The SAM HOME Gateway is used to facilitate the integration of Modbus devices into the cloud-based SAM DISTRICT ENERGY. Default settings are available for the interfaces. Additional settings can be adapted to integrate other Modbus RTU devices (i.e. Baud rate and parity of both interfaces).

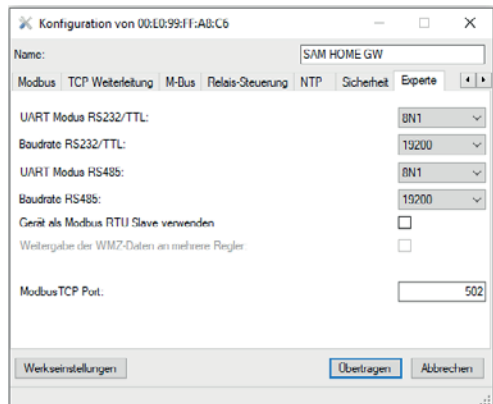

The expert configuration in the start window must be activated in the settings before the function can be used. Enter the password 'Kundendienst' to activate these settings.

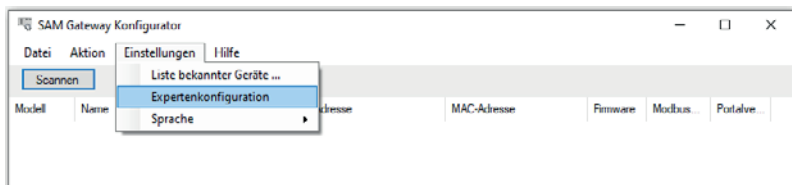

UART mode RS-232, TTL or RS-485	Setting the UART mode The parity can be selected (N: none, E: even or O: odd).
Baud rate RS-232, TTL or RS-485	Baud rate of the interface
Forwarding of meter data to several controllers	Forwarding of M-Bus data also over the RS-485 interface In this case, the forwarding must be activated first in the 'M-Bus' tab. Further information can be found in the corresponding tab as well as the mounting and operating instructions of the gateway.
Use device as Modbus RTU slave	Configuration of the Modbus RTU interfaces (RS-232, TTL, RS-248) in the Modbus RTU slave mode Modbus requests can then be received over these interfaces and forward over Modbus TCP, for example. Forwarding to known Modbus TCP servers can be configured in the 'TCP forwarding' tab.
Gateway address	Modbus address of the gateway <ul style="list-style-type: none"> - It is possible to access internal data on the gateway. - The gateway address must not be the same as the station address of the controller that is assigned to the gateway. - The setting can be found in the 'Modbus' tab of devices with a Modbus RTU function.
Modbus TCP port	Port number for the Modbus TCP server of the device (standard 502)

i Note

A corresponding note appears in the bottom section of the tab when the default setting is changed. Click the 'Default setting' button to reset the parameter settings back to the SAMSON-compatible standard (only for devices with Modbus RTU interface).

8 Operation

Network data transmission takes place while the gateway is operating. A direct connection to the Internet is established during operation. Communication using the Modbus TCP protocol is protected against transmission errors by checksum mechanisms.

→ Take appropriate data security measures to prevent unauthorized access.

8.1 LED status indication

The LEDs of the SAM HOME Gateway indicate the operating and communication state of the gateway.

LED	Meaning
Red	Error
Blinking	Restricted functions
Green (permanently)	Device functioning properly
Yellow (permanently)	Device functioning properly

9 Malfunctions

9.1 Troubleshooting

→ See Table 9-1 and Table 9-2.

Table 9-1: Troubleshooting (1)

Error	Possible reasons	Recommended action
Power LED not illuminated.	The gateway is not powered with the specified voltage supply.	→ Check the power supply (see the 'Design and principle of operation' and 'Installation' sections).

When the supply voltage is connected, errors are indicated through the use of different blinking patterns at the **error LED**.

Table 9-2: Troubleshooting (2)

Blinking frequency of the error LED	Error	Possible reasons	Recommended action
Blinks 1x	Communication error – Modbus RTU (RS-232, RS-485, TTL)	Loose or defective connecting cables	→ Check the connecting cables. NOTICE: After an automatic device search in the SAM DISTRICT ENERGY web portal, the status appears for a short period and goes out again after 10 minutes.
Blinks 8x	Meter bus communication error	Connected M-Bus device is defective	→ Check the M-Bus device.
Blinks 9x	Meter bus meter error	Meter configuration in the gateway is incorrect	→ Check the meter configuration in the gateway (SAM Gateway Configurator).
		Connected meter is defective	→ Check meter.

Malfunctions

Blinking frequency of the error LED	Error	Possible reasons	Recommended action
Blinks 10x	Connection to web portal not possible	SAM DISTRICT ENERGY is offline (e.g. due to maintenance work).	No action As soon as SAM DISTRICT ENERGY is online again, the gateway automatically reconnects.
Blinks 11x	No valid ZBD file exists	A corrupt file or no file has been loaded.	→ Contact SAMSON's After-sales Service.
Blinks 12x	Modbus TCP forwarding	Error during Modbus TCP forwarding in the gateway or the Modbus TCP server cannot be reached as a participant (e.g. controller)	→ Check the Ethernet/ broadband wiring. → Check the configuration settings in the gateway (SAM Gateway Configurator tool).

i Note

Contact SAMSON's After-sales Service for malfunctions not listed.

9.2 Emergency action

Plant operators are responsible for emergency action to be taken in the plant.

10 Servicing

The work described in this section is only to be performed by personnel appropriately qualified to carry out such tasks.

We recommend inspection and testing according to Table 10-1.

Table 10-1: *Recommended inspection and testing*

Inspection and testing	Action to be taken in the event of a negative result
Check the markings, labels and nameplates on the gateway for their readability and completeness.	→ Immediately renew damaged, missing or incorrect nameplates or labels.
	→ Clean any inscriptions that are covered with dirt and are illegible.
Check the electric wiring.	→ If any terminal screws are loose, tighten them (see the 'Installation' section).
	→ Renew damaged wires.

11 Decommissioning

The work described in this section is only to be performed by personnel appropriately qualified to carry out such tasks.

DANGER

Risk of fatal injury due to electric shock.

- *Only allow trained and experienced personnel to perform the work.*
 - *Before disconnecting live wires, switch off the supply voltage and protect it against unintentional reconnection.*
-
- Disconnect the supply voltage and protect it against unintentional reconnection.

12 Removal

The work described in this section is only to be performed by personnel appropriately qualified to carry out such tasks.

⚠ DANGER

Risk of fatal injury due to electric shock.

- *Only allow trained and experienced personnel to perform the work.*
 - *Before disconnecting live wires, switch off the supply voltage and protect it against unintentional reconnection.*
-

1. Undo the screws on the front cover.
2. Carefully pull the gateway device off the base.
3. Remove the PCB on which the SIM card is mounted.
4. Disconnect the wires (supply voltage) at terminals 18 and 19.
5. Disconnect all wires of the externally fed cables from the terminals.
6. Remove grommets or cable glands fitted at the cable entry and pull the cables out of the terminal compartment.

Panel mounting

- Push the base through the panel cut-out.

Rail mounting

- Slightly push the base upwards, pull the top hook out of the top hat rail and remove the base.

Wall mounting

- Unscrew the base.

13 Repairs

A defective gateway must be repaired or replaced.

! NOTICE

Risk of gateway damage due to incorrect service or repair work.

- *Do not perform any repair work on your own.*
 - *Contact SAMSON's After-sales Service for service and repair work.*
-

13.1 Returning devices to SAMSON

Defective gateways can be returned to SAMSON for repair.

Proceed as follows to return devices to SAMSON:

1. Put the gateway out of operation (see the 'Decommissioning' section).
2. Remove the gateway (see the 'Removal' section).
3. Proceed as described on the Returning goods page of our website
 - ▶ www.samsongroup.com > Service & Support > After-sales Service > Returning goods

14 Disposal



SAMSON is a producer registered at the following European institution
▶ <https://www.ewrn.org/national-registers/national-registers>.
WEEE reg. no.:
DE 62194439/FR 025665

- Observe local, national and international refuse regulations.
- Do not dispose of components and hazard substances together with your other household waste.

i Note

We can provide you with a recycling passport according to PAS 1049 on request. Simply e-mail us at aftersaleservice@samsongroup.com giving details of your company address.

Tip

On request, we can appoint a service provider to dismantle and recycle the product as part of a distributor take-back scheme.

15 Certificates

The following certificate is shown on the next page:

- EU declaration of conformity

The certificate shown was up to date at the time of publishing. The latest certificate can be found on our website at:

▶ www.samsongroup.com > Products & Applications > Product selector > Automation Systems > SAM HOME Gateway > Downloads

EU declaration of conformity



EU Konformitätserklärung / EU Declaration of Conformity / Déclaration UE de conformité

Die alleinige Verantwortung für die Ausstellung dieser Konformitätserklärung trägt der Hersteller/
This declaration of conformity is issued under the sole responsibility of the manufacturer/
La présente déclaration de conformité est établie sous la seule responsabilité du fabricant.
Für das folgende Produkt / For the following product / Nous certifions que le produit

SAM HOME Gateway
Typ/Type/Type 5660

wird die Konformität mit den einschlägigen Harmonisierungsrechtsvorschriften der Union bestätigt/
the conformity with the relevant Union harmonisation legislation is declared with/
est conforme à la législation d'harmonisation de l'Union applicable selon les normes:

EMC 2014/30/EU	EN 61000-6-3:2007/A1:2011/AC:2012 EN 61000-6-4:2007/A1:2011, EN 55022 :2010/AC:2011, EN61000-6-1:2007
LVD 2014/35/EU	EN 60950-1:2006/AC:2011
RoHS 2011/65/EU	EN 50581:2012

Hersteller / Manufacturer / Fabricant:

SAMSON AKTIENGESELLSCHAFT
Weismüllerstraße 3
D-60314 Frankfurt am Main
Deutschland/Germany/Allemagne

Frankfurt / Francfort, 2018-12-17

Im Namen des Herstellers/ On behalf of the Manufacturer/ Au nom du fabricant.

Gert Nahler
Zentralabteilungsleiter/Head of Department/Chef de département
Entwicklung Automation und Integrationstechnologien/
Development Automation and Integration Technologies

Dipl.-Ing. Silke Bianca Schäfer
Total Quality Management/
Management par la qualité totale

eu_5660_de_en_fr_en08.pdf

16 Annex

16.1 Accessories

Designation	Description	Order no.
iCon485	Adapter to connect the TROVIS 5573 or 5578 Controller to a RS-485 bus	8812-2002
CoRe02	Converter/repeater or RS-232 or RS-485 interface	1400-9670
SAM DISTRICT ENERGY	Connection of TROVIS (heating) controllers to the web portal	900000131
SAM DISTRICT ENERGY	Connection of utility meters to the web portal	900000130
SAM DISTRICT ENERGY	Connection of Type 3374 or 3375 Electric Actuators to the web portal	900000269
SAM DISTRICT ENERGY	Connection of TROVIS 5724-8 or 5725-8 Electric Actuators with Process Controller to the web portal	900000266

16.2 After-sales service

Contact our after-sales service for support concerning service or repair work or when malfunctions or defects arise.

After-sales service

Contact our after-sales service for support concerning service or repair work or when malfunctions or defects arise.

You can reach our after-sales service at aftersaleservice@samsongroup.com.

Addresses of SAMSON AG and its subsidiaries

The addresses of SAMSON, its subsidiaries, representatives and service facilities worldwide can be found on our website (www.samsongroup.com) or in all product catalogs.

Annex

Required specifications

Please submit the following details:

- Type number
- Firmware version
- Serial number

Default password	
User	Admin
Password	Kundendienst

EB 5660 EN



SAMSON AKTIENGESELLSCHAFT
Weismüllerstraße 3 · 60314 Frankfurt am Main, Germany
Phone: +49 69 4009-0 · Fax: +49 69 4009-1507
samson@samsongroup.com · www.samsongroup.com