

MOUNTING AND OPERATING INSTRUCTIONS



EB 5724 EN

Translation of original instructions



TROVIS 5724-3 (without fail-safe action)
TROVIS 5725-3 (with fail-safe action)
Electric Actuators with Process Controller
for domestic hot water heating

Firmware version 2.20



Edition August 2016

Note on these mounting and operating instructions

These mounting and operating instructions assist you in mounting and operating the device safely. The instructions are binding for handling SAMSON devices. The images shown in these instructions are for illustration purposes only. The actual product may vary.

- For the safe and proper use of these instructions, read them carefully and keep them for later reference.
- If you have any questions about these instructions, contact SAMSON's After-sales Service (aftersaleservice@samsongroup.com).



Documents relating to the device, such as the mounting and operating instructions, are available on our website at www.samsongroup.com > **Downloads > Documentation.**

Definition of signal words

DANGER

Hazardous situations which, if not avoided, will result in death or serious injury

WARNING

Hazardous situations which, if not avoided, could result in death or serious injury

NOTICE

Property damage message or malfunction

Note

Additional information

Tip

Recommended action

1	Safety instructions and measures	1-1
1.1	Notes on possible severe personal injury	1-4
1.2	Notes on possible personal injury	1-5
1.3	Notes on possible property damage	1-6
2	Markings on the device	2-1
2.1	Nameplate	2-1
2.2	Device code	2-2
2.3	Firmware versions	2-2
3	Design and principle of operation	3-1
3.1	Fail-safe action	3-2
3.2	Communication	3-3
3.3	Technical data	3-4
3.4	Dimensions	3-6
4	Shipment and on-site transport	4-1
4.1	Accepting the delivered goods	4-1
4.2	Removing the packaging from the actuator	4-1
4.3	Transporting the actuator	4-1
4.4	Lifting the actuator	4-1
4.5	Storing the actuator	4-1
5	Installation	5-1
5.1	Installation conditions	5-1
5.1	Preparation for installation	5-1
5.2	Aligning the travel indication scale	5-2
5.3	Mounting the actuator	5-2
5.3.1	TROVIS 5724-3 (force-locking attachment)	5-2
5.3.2	TROVIS 5724-3 (form-fit attachment)	5-3
5.3.3	TROVIS 5725-3 (force-locking attachment)	5-4
5.3.4	TROVIS 5725-3 (form-fit attachment)	5-4
5.4	Installing the control valve into the pipeline	5-4
5.5	Installing the accessories	5-5
5.6	Electrical connection	5-5
6	Operation	6-1
6.1	Device overview and operating controls	6-1
6.2	Indication with LEDs	6-2
6.3	Automatic set point potentiometer	6-2
6.4	Serial interface	6-2

Contents

7	Start-up and configuration	7-1
7.1	Initializing the actuator	7-1
7.2	Configuring the actuator	7-1
7.3	Quick check	7-2
8	Operation	8-1
8.1	Closed-loop control	8-1
8.2	LED blinking pattern	8-1
8.3	Change set point at the device	8-3
8.4	Manual mode	8-4
8.4.1	Mechanical override	8-4
8.5	Operation using memory pen	8-5
8.5.1	Copying function	8-7
8.5.2	Command mode	8-8
8.6	Readings in TROVIS-VIEW	8-8
8.6.1	Operating values	8-8
8.6.2	Operating states	8-8
8.6.3	Functions	8-8
8.6.4	Status messages	8-9
8.6.5	Statistics	8-10
9	Malfunctions	9-1
9.1	Troubleshooting	9-1
9.2	Error indication by LEDs	9-2
9.3	Emergency action	9-3
10	Servicing	10-1
11	Decommissioning	11-1
12	Removal	12-1
12.1	Force-locking attachment	12-1
12.2	Form-fit attachment	12-1
13	Repairs	13-1
13.1	Returning the actuator to SAMSON	13-1
14	Disposal	14-1
15	Certificates	15-1
16	Annex	16-1
16.1	Accessories	16-1
16.2	After-sales service	16-2
16.3	Configuration and parameter list.....	16-3
16.4	Customer-specific data	16-5

1 Safety instructions and measures

Intended use

The TROVIS 5724-3 and TROVIS 5725-3 Electric Actuators with Process Controller are electric actuators with an integrated digital controller. They are designed for operating a mounted globe valve. In combination with the valve, the electric actuators with process controller are used to control the flow of liquids in the pipeline. The electric actuators with process controller are suitable for closed-loop operation in DHW applications.

The actuators are designed to operate under exactly defined conditions (e.g. thrust, travel). Therefore, operators must ensure that the actuators are only used in operating conditions that meet the specifications used for sizing the actuator at the ordering stage. In case operators intend to use an actuator in applications or conditions other than those specified, contact SAMSON.

SAMSON does not assume any liability for damage resulting from the failure to use the device for its intended purpose or for damage caused by external forces or any other external factors.

→ Refer to the technical data for limits and fields of application as well as possible uses. See the 'Design and principle of operation' section.

Reasonably foreseeable misuse

The electric actuators with process controller are not suitable for the following applications:

- Use outside the limits defined during sizing and by the technical data
- Outdoor use

Furthermore, the following activities do not comply with the intended use:

- Use of non-original spare parts
- Performing service and repair work not described

Qualifications of operating personnel

The electric actuators with process controller must be mounted, started up, serviced and repaired by fully trained and qualified personnel only; the accepted industry codes and practices are to be observed. According to these mounting and operating instructions, trained personnel refers to individuals who are able to judge the work they are assigned to and recognize possible hazards due to their specialized training, their knowledge and experience as well as their knowledge of the applicable standards.

Safety instructions and measures

Personal protective equipment

No personal protective equipment is required for the direct handling of electric actuators. Work on the control valve may be necessary when mounting or removing the device.

- Observe the requirements for personal protective equipment specified in the valve documentation.
- Check with the plant operator for details on further protective equipment.

Revisions and other modifications

Revisions, conversions or other modifications of the product are not authorized by SAMSON. They are performed at the user's own risk and may lead to safety hazards, for example. Furthermore, the product may no longer meet the requirements for its intended use.

Safety features

The limit switches switch off the motor in the end positions.

Upon supply voltage failure, the TROVIS 5725-3 Electric Actuator with Process Controller causes the valve to move to a certain fail-safe position. The direction of the fail-safe action is specified on the nameplate of SAMSON actuators.

Warning against residual hazards

The electric actuator with process controller has a direct influence on the valve when it is mounted on the valve. To avoid personal injury or property damage, plant operators and operating personnel must prevent hazards that could be caused in the control valve by the process medium, the operating pressure, the signal pressure or by moving parts by taking appropriate precautions. Plant operators and operating personnel must observe all hazard statements, warnings and caution notes in these mounting and operating instructions, especially for installation, start-up and service work.

Responsibilities of the operator

Operators are responsible for proper use and compliance with the safety regulations. Operators are obliged to provide these mounting and operating instructions as well as the referenced documents to the operating personnel and to instruct them in proper operation. Furthermore, operators must ensure that operating personnel or third parties are not exposed to any danger.

Responsibilities of operating personnel

Operating personnel must read and understand these mounting and operating instructions as well as the referenced documents and observe the specified hazard statements, warnings and caution notes. Furthermore, operating personnel must be familiar with the applicable health, safety and accident prevention regulations and comply with them.

Referenced standards, directives and regulations

Devices with a CE marking fulfill the requirements of the following Directives:

- 2014/30/EU
- 2014/35/EU
- 2011/65/EU

Devices with an EAC marking fulfill the requirements of the following Regulations:

- TR CU 004/2011
- TR CU 020/2011

The 'Certificates' section contains these declarations of conformity and TR CU certificate.

The electric actuators are designed for use in low-voltage installations.

→ For wiring, maintenance and repair, observe the relevant safety regulations.

Referenced documentation

The following documents apply in addition to these mounting and operating instructions:

- Configuration Manual for TROVIS 5724-3 and TROVIS 5725-3 Electric Actuators with Process Controller ► KH 5724
- Mounting and operating instructions of the valve on which the electric actuator is mounted, e.g. for SAMSON valves:
 - EB 5861 for Type 3260 Three-way Valve
 - EB 5863 for Type 3226 Three-way Valve
 - EB 5866 for Type 3222 Globe Valve
 - EB 5867 for Type 3222 N Globe Valve
 - EB 5868 for Type 3213 and Type 3214 Globe Valves
 - EB 8111 for Type 3321 Globe Valve
 - EB 8113 for Type 3323 Three-way Valve
 - EB 8131 for Type 3531 Globe Valve for Heat Transfer Oil
 - EB 8135 for Type 3535 Three-way Valve for Heat Transfer Oil
 - EB 3018 for Type 42-36 E Pressure-independent Control Valve (PICV) with electric actuator

1.1 Notes on possible severe personal injury

DANGER

Risk of fatal injury due to electric shock.

- Before connecting wiring and performing any work on the device, disconnect the supply voltage and protect it against unintentional reconnection.
- Only use power interruption devices that can be protected against unintentional reconnection of the power supply.
- Do not open the back housing cover.

The electric actuators with process controller are protected against spray water (IP 54).

- Avoid jets of water.

The switching output L' may be live after the supply voltage has been connected.

- Do not touch the switching output L'.
- When the switching output is not used, deactivate it in function **F16** ('Not active' setting ► KH 5724).

1.2 Notes on possible personal injury

WARNING

Crush hazard arising from moving parts.

The form-fit version of the electric actuators contains moving parts (actuator and plug stems), which can injure hands or fingers if inserted into the actuator.

- Do not insert hands or finger into the yoke while the valve is in operation.
- Disconnect the supply voltage before performing any work on the control valve.
- Do not impede the movement of the actuator or plug stem by inserting objects into their path.

Risk of personal injury through incorrect operation, use or installation as a result of information on the actuator being illegible.

Over time, markings, labels and nameplates on the actuator may become covered with dirt or become illegible in some other way. As a result, hazards may go unnoticed and the necessary instructions not followed. There is a risk of personal injury.

- Keep all relevant markings and inscriptions on the device in a constantly legible state.
- Immediately renew damaged, missing or incorrect nameplates or labels.

1.3 Notes on possible property damage

! NOTICE

Risk of actuator damage due to the supply voltage exceeding the permissible tolerances.

The actuator is designed for use according to regulations for low-voltage installations.

→ Observe the permissible tolerances of the supply voltage.

Risk of actuator damage due to incorrect wiring of the inputs.

Incorrect wiring of the inputs may lead to excessively high voltages and damage the electric actuator with process controller.

→ Wire the inputs range according to the technical data.

Risk of actuator damage due to excessively high tightening torques.

The connection of the electric actuator must be tightened with certain torques. Excessive tightening torques lead to parts wearing out more quickly.

→ Observe the specified tightening torques.

Risk of damage to the actuator by moving the actuator stem too far.

The actuator stem of the electric actuators can be adjusted manually.

→ Move the actuator stem only as far as the bottom or top end position.

Malfunction due to a configuration that does not meet the requirements of the application.

The electric actuator with process controller is configured for the specific application by setting configuration items and parameters.

→ Perform the configuration for the specific application during start-up and after a reset to default settings.

! NOTICE

Risk of damage to the screw heads on the front cover due to the use of the wrong tool.

The actuator housing cover is fastened using TORX PLUS® screws, size 10IP.

- To screw or unscrew the screws, only use the following screwdrivers:
- TORX® T10
 - TORX PLUS® 10IP
 - Flat-blade screwdriver with 0.8 mm blade thickness and 4.0 mm blade width

Risk of actuator damage due to direct contact with steam.

- During mounting, make sure that the actuator cannot come into contact with a jet of steam during operation.

2 Markings on the device

2.1 Nameplate

The nameplate shown was up to date at the time of publication of this document. The nameplate on the device may differ from the one shown.

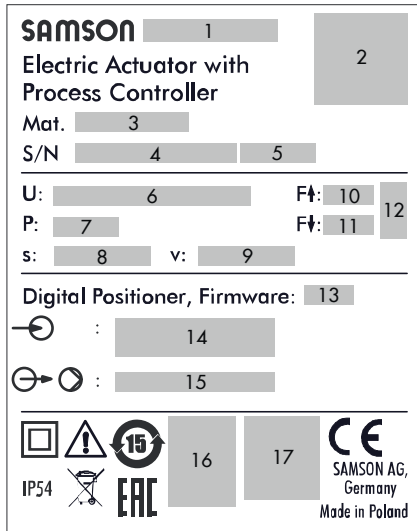

- 1 Type designation
- 2 DataMatrix code
- 3 Material no.
- 4 Serial number
- 5 Date of manufacture
- 6 Supply voltage; power line frequency
- 7 Power consumption
- 8 Rated travel
- 9 Stroking speed
- 10 Thrust (actuator stem retracts)
- 11 Thrust (actuator stem extends)
- 12 Fail-safe action (TROVIS 5725-3 only)
- 13 Firmware version
- 14 Inputs
- 15 Outputs
- 16 DIN registration number (TROVIS 5725-3 only)
- 17 Other mark of conformity

Markings on the device

2.2 Device code

Electric Actuator with Process Controller		TROVIS 572	x	-	3	x	x
Fail-safe action							
	Without	4					
	With	5					
Rated travel/adaptation							
	6 mm/force locking					1	
	12 mm/force locking					2	
	15 mm/form-fit					3	
Stem movement							
	Standard						0
	Double stroking speed						3

2.3 Firmware versions

Firmware revisions	
Old	New
2.11	2.13
	Additional setting option 'Circulation pump (heating) reversed' in Function of switching output (F16) (see Annex and Configuration Manual ► KH 5724).
2.13	2.20
	New pump protection function (F17) (see Annex and Configuration Manual ► KH 5724).

3 Design and principle of operation

The TROVIS 5724-3 and TROVIS 5725-3 Electric Actuators with Process Controller consist of a linear actuator with an integrated digital controller.

They are especially designed for DHW heating in instantaneous heating systems for small to medium-sized buildings and for fixed set point control circuits in mechanical engineering applications. They are particularly suitable for mounting to SAMSON Types 3213, 3214, 3260, 3222 and 3226 Valves.

A special version of Type 3222 (DN 15) and Type 3222 N 8DN 15) with a special plug design is available for small installations

(apartment or house). As a result, even small tapping amounts can be controlled.

Design

➔ See Fig. 3-1.

The electric actuator with process controller contains a reversible synchronous motor and a maintenance-free gear. The synchronous motor is switched off by torque-dependent switches in the end positions or in case of overload.

The output signal of the integrated digital controller acts over the positioner on the synchronous motor of the actuator. The force of the motor is transmitted to the actuator stem (3) via gear and crank disk. When the actu-

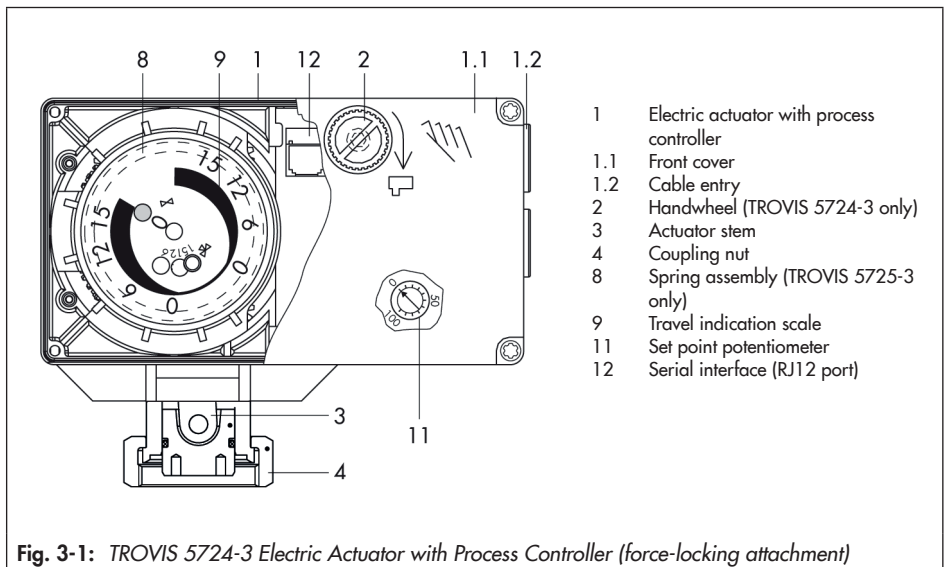

Design and principle of operation

ator stem extends, it presses on the plug stem (10) of the valve.

When the actuator stem retracts (force-locking attachment), the plug stem follows the movement of the actuator stem as a result of the return spring in the valve.

When the actuator stem retracts (form-fit attachment), the plug stem is connected to the actuator stem and follows its movement.

Manual override

➔ See the 'Operation' section.

The actuator version without fail-safe action (TROVIS 5724-3) has a handwheel used to manually position the valve (only when the actuator is disconnected from the power supply). Travel and direction of action can be read off the travel indication scale.

Inputs

The integrated digital controller must be connected to a temperature sensor on the input side, which can be optionally upgraded by a water flow sensor or a flow switch.

Alternatively, a current signal can be used for mechanical engineering applications.

A binary input is used to switch between two internal set points or, alternatively, can be used to deactivate the function to maintain the heat exchanger at a constant temperature.

Outputs

A circulation pump can be controlled with the 230 V switching output (see Technical data in section 3.3).

Alternatively, the switching output can be used as fault alarm output or can be configured to register the tapping of hot water. The actuator is configured with the TROVIS-VIEW software.

Setting

The set point of the digital controller is set to 60 °C and a second set point is set to 70 °C. They can be changed in TROVIS-VIEW using a connecting cable connected to the RS-232 interface (serial interface) on the actuator or using a memory pen.

The set point can also be adjusted at the set point potentiometer on the device (see the 'Operation' section).

The controlled variable, control behavior and other parameters can be changed in this way.

All the functions and parameters are listed in the Annex.

3.1 Fail-safe action

The TROVIS 5725-3 Electric Actuator with Process Controller contains a spring mechanism and an electromagnet. The actuator stem is moved by the force of the spring to the fail-safe position when the electromagnet (connected to terminals L and N) is de-energized.

i Note

The actuator stem of TROVIS 5724-3 remains in its last position in the event of supply voltage failure.

The TROVIS 5725-3 Electric Actuator with Process Controller is only available with fail-safe action "actuator stem extends". Upon supply voltage failure, the actuator stem extends.

i Note

The fail-safe action must not be used to control the valve position.

The TROVIS 5725-3 does not have a hand-wheel (2) on the housing cover. Manual override is possible, after removing the front cover, using a 4 mm Allen key. The actuator stem immediately moves again to the lower end position after the Allen key is removed from the actuating shaft.

Testing according to DIN EN 14597

The TROVIS 5725-3 Electric Actuator with Process Controller with fail-safe action "actuator stem extends" is tested by the German technical surveillance association TÜV according to DIN EN 14597 in combination with different SAMSON valves. The register number is available on request.

3.2 Communication

Serial interface

The actuator is fitted with an RS-232 serial interface. This allows communication with TROVIS-VIEW using SSP protocol.

Configuration

The actuator is configured using the TROVIS-VIEW software that enables the user to easily configure the controller as well as view process parameters online.

i Note

TROVIS-VIEW can be downloaded free of charge from our website at ► Service & Support > Downloads > TROVIS-VIEW. Further information on TROVIS-VIEW (e.g. system requirements) is available on our website and in the Data Sheet ► T 6661 as well as the Operating Instructions ► EB 6661.

3.3 Technical data

Electric actuator with process controller	TROVIS	5724						5725					
		-310	-313	-320	-323	-330	-333	-310	-313	-320	-323	-330	-333
Fail-safe action		Without						Extends					
Rated travel	mm	6	6	12	12	15	15	6	6	12	12	15	15
Transit time for rated travel	s	35	18	70	36	90	45	35	18	70	36	90	45
Transit time for fail-safe action	s	-						4	4	6	6	7	7
Thrust	N	700						500			280		
Thrust in the event of fail-safe action	N	-						500			280		
Attachment	Force-locking	•	•	•	•			•	•	•	•		
	Form-fit					•	•					•	•
Manual adjuster		Yes						Possible ¹⁾					
Supply voltage		230 V (±10 %), 50 Hz						230 V (±10 % ²⁾), 50 Hz					
Power consumption	Approx. VA	4	8	4	8	4	8	5.5	9.5	5.5	9.5	5.5	9.5
Permissible temperature ranges ³⁾													
Ambient		0 to 50 °C						0 to 50 °C					
Storage		-20 to +70 °C						-20 to +70 °C					
Safety													
Degree of protection		IP 54 according to EN 60529 ⁴⁾											
Class of protection		II according to EN 61140											
Device safety		II according to EN 61010-1											
Noise immunity		According to EN 61000-6-2 and EN 61326-1											
Noise emission		According to EN 61000-6-3 and EN 61326-1											
Vibration		According to EN 61000-6-2 and EN 60068-2-27											
Conformity													
Inputs and outputs													
Binary input BI1 ⁵⁾		Floating contact for internal set point switchover or to deactivate the function to maintain the heat exchanger at a constant temperature											
Binary input BI2 ⁵⁾		Floating contact to connect a flow switch											
Switching output		230 V, 50 Hz, max. 1 A											
Weight	kg (approx.)	1.1						1.3					

Electric actuator with process controller	TROVIS	5724						5725					
		-310	-313	-320	-323	-330	-333	-310	-313	-320	-323	-330	-333
Accessories													
Temperature sensor	Pt 1000, fast response												
Water flow sensor	530 pulses/l, measuring range 1 to 30 l/min												
Flow switch ⁶⁾	Yes · Alternative to water flow sensor												

- 1) Manual override using 4 mm Allen key (after removing the front cover); actuator always returns to fail-safe position after release.
- 2) For actuators tested according to DIN EN 14597: -15/+10 %
- 3) The permissible medium temperature depends on the valve on which the electric actuator with process controller is mounted. The limits in the valve documentation apply.
- 4) Up to device index **.03** only when the actuator is installed in the upright position. See last two figures of the configuration ID written on the nameplate (see the 'Markings on the device' section), e.g. Var.-ID xxxxxxx.xx, for the device index.
- 5) Recommendation: use versions with gold contacts when using relays.
- 6) The flow switch or water flow sensor is not required in DHW heating in instantaneous systems with a constant circulation.

3.4 Dimensions

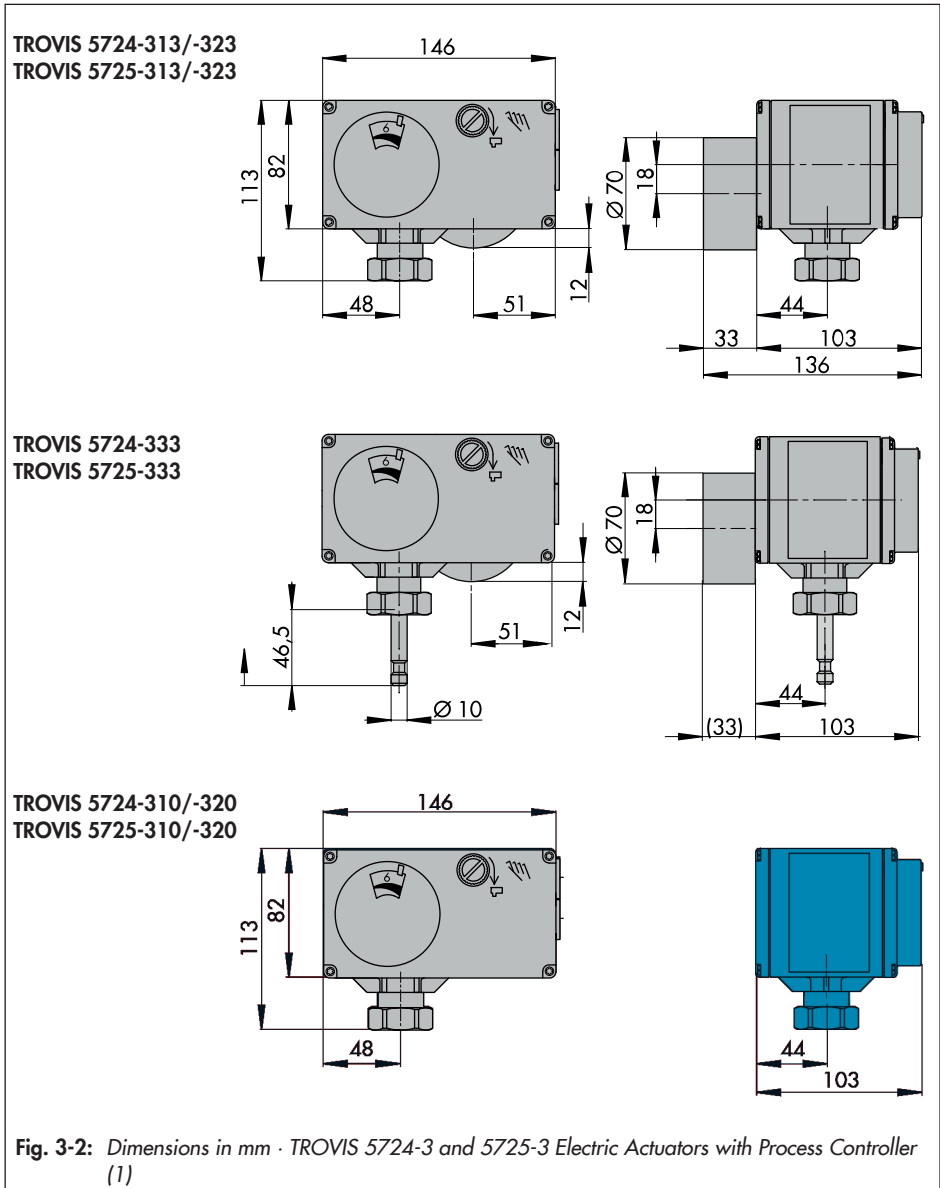
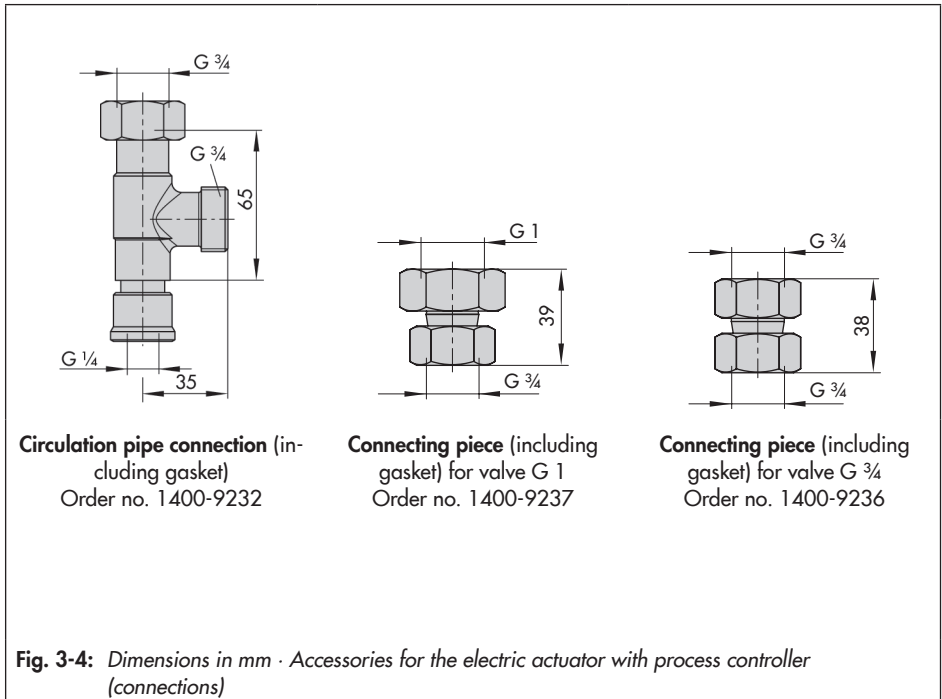
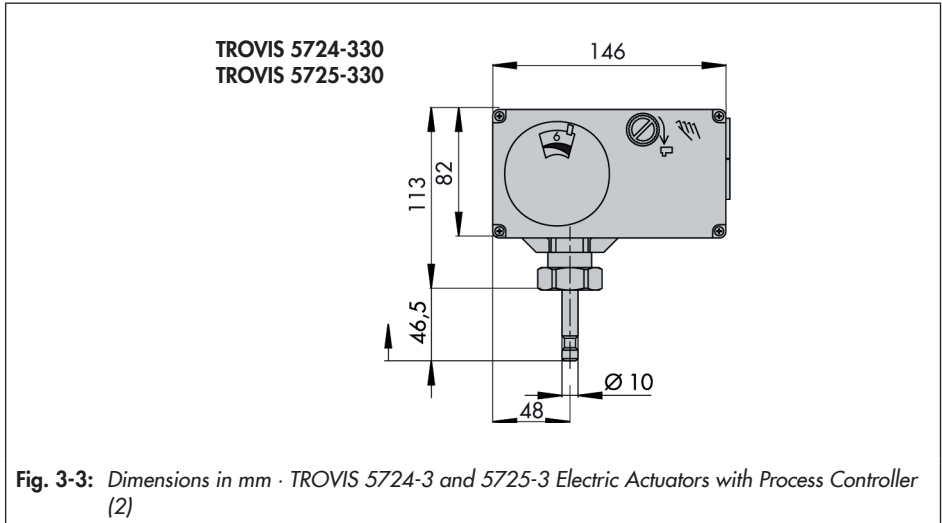
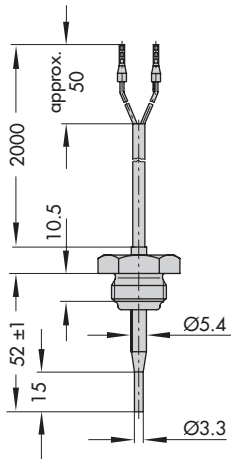

Fig. 3-2: Dimensions in mm · TROVIS 5724-3 and 5725-3 Electric Actuators with Process Controller (1)



Design and principle of operation



Type 5207-0060 Pt 1000 Sensor

Time response: $t_{0.5} < 1$ s,
 $t_{0.9} < 3$ s; in water 0.4 m/s
 PN 16
 Max. medium temperature: 90 °C

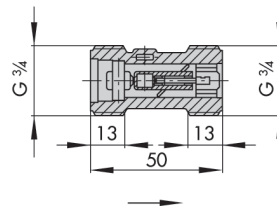

Water flow sensor with extension cable

Order no. 1400-9246
 Measuring range 1 to 30 l/min, DN 10, PN 10,
 IP 54
 Max. medium temperature 70 °C
 Extension cable length: 2 m

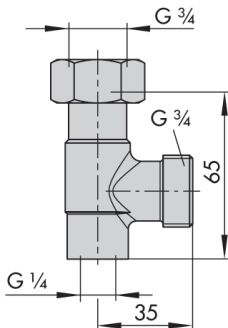

Sensor pocket (including gasket) for heat
 exchanger with G $\frac{3}{4}$
 Order no. 1400-9249

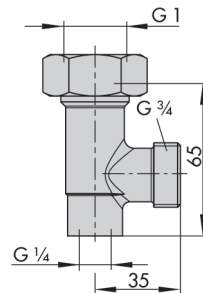

Sensor pocket (including gasket) for heat
 exchanger with G 1
 Order no. 1400-9252

Fig. 3-5: Dimensions in mm and inches · Accessories for the electric actuator with process controller (sensors)

4 Shipment and on-site transport

The work described in this section is only to be performed by personnel appropriately qualified to carry out such tasks.

4.1 Accepting the delivered goods

After receiving the shipment, proceed as follows:

1. Compare the shipment received with the delivery note.
2. Check the shipment for transportation damage. Report any damage to SAMSON and the forwarding agent (refer to delivery note).

4.2 Removing the packaging from the actuator

i Note

Do not remove the packaging until immediately before mounting and start-up.

1. Remove the packaging from the electric actuator.
2. Check scope of delivery (see Fig. 4-1).
3. Dispose of the packaging in accordance with the valid regulations.

- | | |
|----|---|
| 1x | TROVIS 5724-3 or TROVIS 5725-3
Electric Actuator with Process Controller |
| 1x | Document IP 5724
(Important Product Information) |

Fig. 4-1: *Scope of delivery*

4.3 Transporting the actuator

- Protect the electric actuator against external influences (e.g. impact).
- Protect the electric actuator against moisture and dirt.
- Observe the permissible transportation temperature of -20 to $+70$ °C.

4.4 Lifting the actuator

Due to the low service weight, lifting equipment is not required to lift the electric actuator.

4.5 Storing the actuator

! NOTICE

Risk of actuator damage due to improper storage.

- ➔ *Observe the storage instructions.*
 - ➔ *Avoid long storage times.*
 - ➔ *Contact SAMSON in case of different storage conditions or longer storage times.*
-

i Note

We recommend regularly checking the electric actuator with process controller and the prevailing storage conditions during long storage periods.

Storage instructions

- Protect the electric actuator against external influences (e.g. impact).
- Protect the electric actuator against moisture and dirt.
- Make sure that the ambient air is free of acids or other corrosive media.
- Observe the permissible storage temperature from -20 to $+70$ °C.
- Do not place any objects on the electric actuator.

5 Installation

5.1 Installation conditions

Work position

If not described otherwise in the valve documentation, the work position for the control valve is the front view looking onto the operating controls.

Mounting orientation

The control valve can be installed in the pipeline in any desired position. However, a suspended mounting position of the actuator is not permissible (see Fig. 5-1).

The cable gland must not face upward after installation.

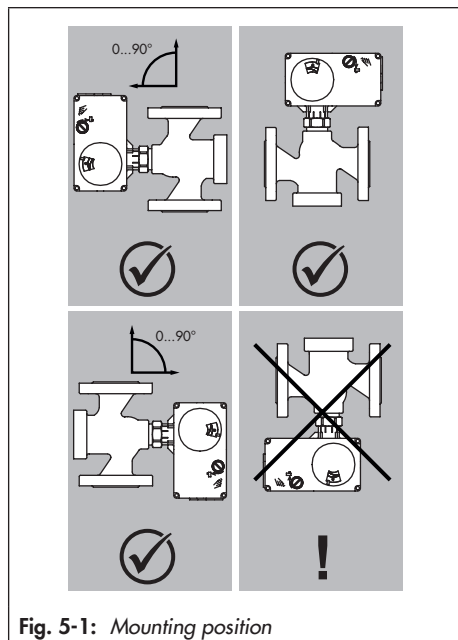

Fig. 5-1: Mounting position

i Note

The degree of protection IP 54 can only be achieved up to device index .03 when the actuator is installed in the upright position. See the last two figures of the configuration ID written on the nameplate for the device index.

! NOTICE

Risk of damage or malfunction due to adverse weather conditions.

→ Do not install the actuator outdoors.

5.1 Preparation for installation

Before installation, make sure the following conditions are met:

- The electric actuator with process controller is not damaged.

Proceed as follows:

Lay out the necessary material and tools to have them ready during installation work.

Cover screws

The actuator housing cover is fastened using TORX PLUS® screws, size 10IP.

- To screw or unscrew the screws, the following screwdrivers can be used:
- TORX® T10
 - TORX PLUS® 10IP
 - Flat-blade screwdriver with 0.8 mm blade thickness and 4.0 mm blade width

5.2 Aligning the travel indication scale

The travel indication scale has two opposed scales. Which scale is to be used depends on the valve version. In the delivered state, the scale alignment applies to globe valves and three-way diverting valves. The alignment needs to be changed when a three-way mixing valve is used.

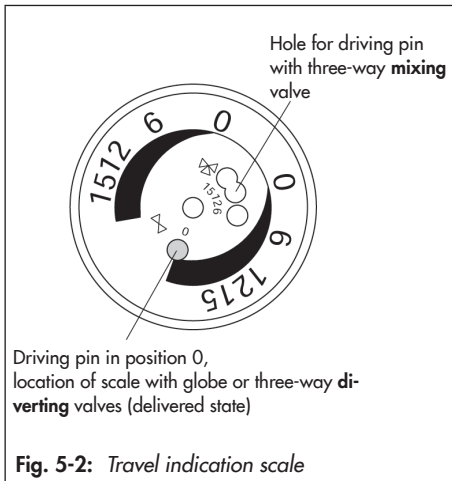

Globe and three-way diverting valves: the driving pin is in position 0 (delivered state).

Three-way mixing valve: change the alignment of the scale.
 → Carefully open the front cover.

Tip

We recommend screwing the bottom screws of the open housing front cover into the top holes of the housing.

- Remove scale, turn it and replace it so that the pin is positioned over the appropriate hole (6, 12 or 15) corresponding to the rated travel (6, 1 or 15 mm travel).
- Close front cover.

5.3 Mounting the actuator

The actuator is mounted either directly onto the valve or using a yoke depending on the valve version used (see Fig. 5-3).

NOTICE

Risk of actuator damage due to excessively high tightening torques.

- Observe the tightening torque.

NOTICE

Risk of damage to the actuator by moving the actuator stem too far.

- Only turn the handwheel far enough to move the actuator to the end positions at the maximum.

5.3.1 TROVIS 5724-3 (force-locking attachment)

1. Turn the handwheel (3) counterclockwise to retract the actuator stem.
2. Place the actuator on the valve connection and fasten with the coupling nut (2).

Tightening torque	20 Nm
-------------------	-------

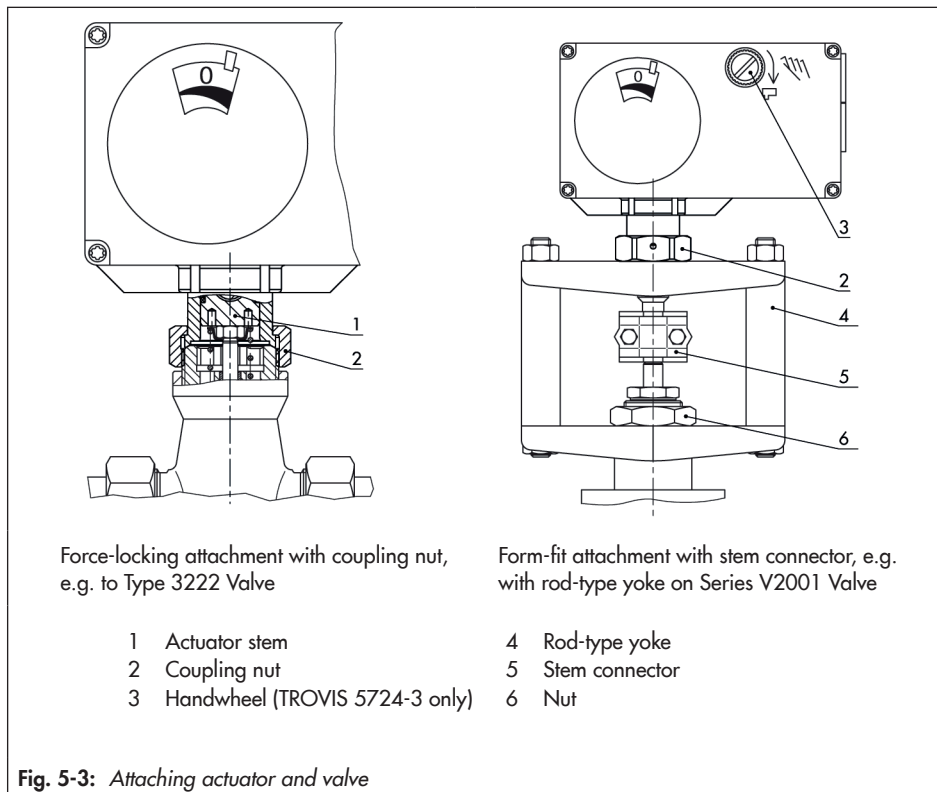

5.3.2 TROVIS 5724-3 (form-fit attachment)

NOTICE

Crush hazard arising from moving parts (actuator and plug stem).

→ Do not insert hands or finger into the yoke while the valve is in operation.

1. Place the actuator on the yoke (4) and fasten with the coupling nut (2).

Tightening torque	20 Nm
-------------------	-------

2. Place actuator with yoke on the valve and tighten the nut (6).

Tightening torque	150 Nm
-------------------	--------

3. Pull plug stem until it reaches the actuator stem or extend actuator stem using the handwheel (3).

Installation

4. Position the clamps of the stem connector (5) included in the accessories on the ends of the actuator stem and plug stem and screw tight.

5.3.3 TROVIS 5725-3 (force-locking attachment)

Actuators with fail-safe action

The actuator stem must be retracted before the actuator can be mounted onto the valve. The stem can be retracted either mechanically or electrically. Both methods are described below.

Retracting the actuator stem mechanically

1. Unfasten the front housing cover and place a 4 mm Allen key on the red actuating shaft.
2. Retract the actuator stem: turn Allen key counterclockwise and only as far as the top end position which is at the point where the torque switch is activated.
3. Hold Allen key in place and fasten valve and actuator together using the coupling nut.

Tightening torque	20 Nm
-------------------	-------

Remove Allen key and carefully replace the front housing cover.

Retracting the actuator stem electrically

1. Unscrew front cover.
2. Connect the wiring as shown in section 5.6.
3. Switch on supply voltage and connect the actuator at the RJ-12 port to the computer.

4. Retract the actuator stem in manual level in TROVIS-VIEW. Fasten valve and actuator together using the coupling nut.

Tightening torque	20 Nm
-------------------	-------

5.3.4 TROVIS 5725-3 (form-fit attachment)

- Install as described in section 5.3.2.

5.4 Installing the control valve into the pipeline

⚠ NOTICE

Degree of protection not achieved due to incorrect mounting position.

- Install the control valve according to section 5.1.

- Install the valve into the pipeline according to the specifications in the mounting and operating instructions of the valve.

⚠ NOTICE

Risk of actuator damage due to direct contact with steam.

- During mounting, make sure that the actuator cannot come into contact with a jet of steam during operation.

5.5 Installing the accessories

DHW tapping recognition

- Install the water flow sensor or flow switch into the pipeline (see associated documentation).

Temperature sensor

- Install the sensor pocket into the pipeline (see associated documentation).



Tip

The sensor must be mounted directly at the heat exchanger.

5.6 Electrical connection



Risk of fatal injury due to electric shock.

- Upon installation of the electric cables, you are required to observe the regulations concerning low-voltage installations according to DIN VDE 0100 as well as the regulations of your local power supplier.
- Use a suitable voltage supply which guarantees that no dangerous voltages reach the device in normal operation or in the event of a fault in the system or any other system parts.
- Only perform the electrical connection after switching off the supply voltage. Make sure the supply voltage cannot be switched on again unintentionally.

The switching output L' is live.

- Do not touch the wire ends of the switching output L'.
 - Insulate the wire ends when the switching output is not used.
-

! NOTICE

Risk of damage to the screw heads on the front cover due to the use of the wrong tool.

- To screw or unscrew the screws, only use TORX® T10, TORX PLUS® 10IP or a flat-blade screwdriver with 0.8 mm blade thickness and 4.0 mm blade width.
-

! NOTICE

Risk of actuator damage due to incorrect wiring of the inputs.

- Wire the inputs range according to the technical data (see the 'Design and principle of operation' section).
-
- Open front cover.
 - Insert the connecting cables through the cable gland.
 - Perform the electrical connection depending on the application according to Fig. 5-4.

Supply voltage and switching output

⚠ DANGER

Live terminal L'!

→ Do not touch.

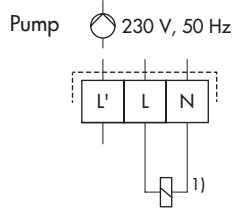

1) Version with fail-safe action only

Temperature sensor and binary inputs

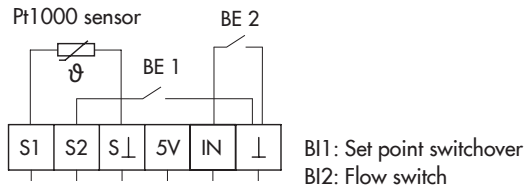

Current input for set point or measured value

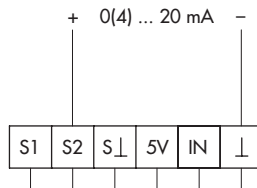
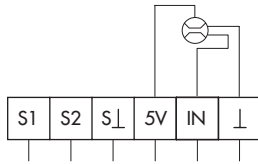

Fig. 5-4: Electrical connection

Water flow sensor (WSS)



WSS		Extension cable		TROVIS 5724-3 TROVIS 5725-3	
GND	BK	————	BN	————	⊥
Signal	GN	————	GN	————	IN
5 V	WH	————	WH	————	5 V

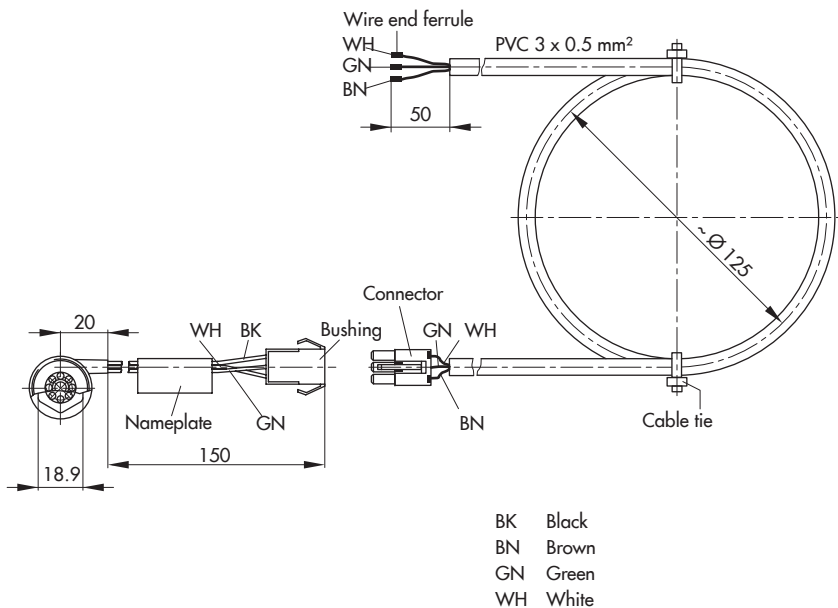

Fig. 5-5: Connection of water flow sensor (WWS)

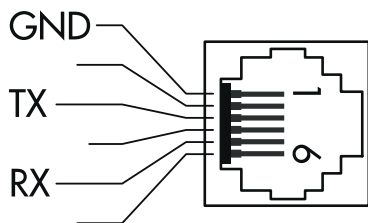
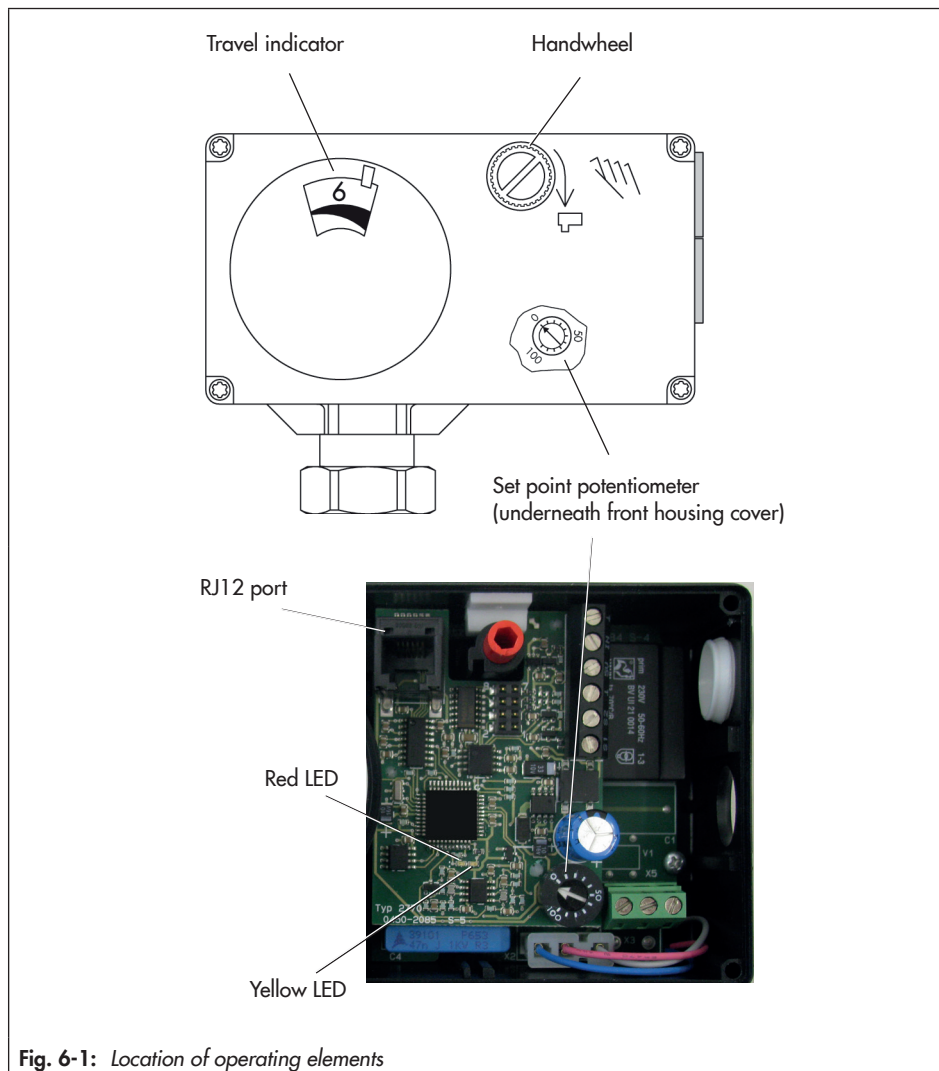

Fig. 5-6: Terminal assignment of RJ-12 jack

6 Operation

6.1 Device overview and operating controls



6.2 Indication with LEDs

The electric actuator with process controller has a red and a yellow LED which indicate the operating state of the actuator. The LEDs are located underneath the cover on the printed circuit board (see Fig. 6-1).

→ See the 'Operation' and 'Malfunctions' sections for the blinking pattern.

6.3 Automatic set point potentiometer

To manually adjust the set point, a set point potentiometer is located on the printed circuit board of the actuator (see Fig. 6-1).

6.4 Serial interface

The serial interface (RJ12 port) is used for communication with the actuator. It is located underneath the housing cover (Fig. 6-1).

7 Start-up and configuration

7.1 Initializing the actuator

The actuator automatically performs a zero calibration as soon as the supply voltage is applied.

The actuator stem extends (when the direction of action increasing/increasing has been set) and the red and yellow LEDs on the printed circuit board are illuminated (see the 'Operation' section).

As soon as the actuator stem has reached the final position, the red LED is turned off.

The yellow LED remains illuminated and indicates that the actuator is ready for use.

➔ Close front cover.

Blinking pattern of the red LED:

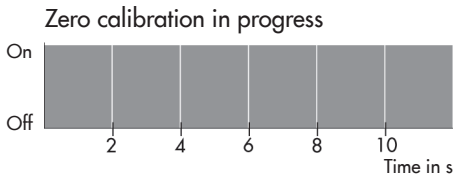

Blinking pattern of the yellow LED (after initialization):

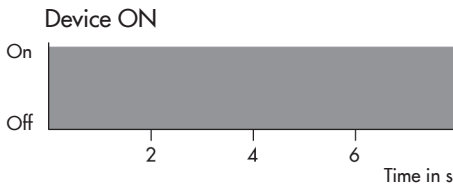

7.2 Configuring the actuator

The actuator is configured with the TROVIS-VIEW software. In this case, the serial interface on the actuator is used to connect the actuator to the computer (see the 'Design and principle of operation' section).

➔ Refer to ► EB 6661 and ► KH 5724 for more details on configuration and operation using TROVIS-VIEW.

i Note

The Configuration Manual ► KH 5724 can be found in the Help menu of the TROVIS-VIEW software. The manual contains a detailed description of each function and parameter.

1. Perform the application-specific configuration in TROVIS-VIEW. See documentation on TROVIS-VIEW software ► EB 6661.
2. Transfer the configuration to the electric actuator using the connecting cable or memory pen.
3. We recommend writing down the configuration made in the Annex.

i Note

All the functions and parameters are listed in the Annex.

7.3 Quick check

To test the electric actuator's ability to function, the following quick checks can be performed:

- Apply the maximum and minimum control signals (e.g. over the manual level in TROVIS-VIEW).
- Check the end positions of the valve.
- Check the travel indicator.

TROVIS 5725-3

- Disconnect the power supply and check whether the valve moves to the fail-safe position.

8 Operation

The valve with electric actuator is ready for use when mounting and start-up have been completed.

! NOTICE

Operation disrupted by a blocked actuator or plug stem (form-fit version).

→ Do not impede the movement of the actuator or plug stem by inserting objects into their path.

8.1 Closed-loop control

The electric actuator with process controller normally operates in closed-loop operation. In this case, the control behavior and movement of the actuator stem depend on the parameter settings (see Configuration Manual ► KH 5724).

Applications

- Pt 1000 sensors
- Pt 1000 sensor with binary contact BI1 to switch between set points
- Pt 1000 sensor with flow switch (BI2)
- Pt 1000 sensor with water flow sensor
- Pt 1000 sensor with set point guided by current input
- Current signal (actual value)
- Pump control using switching output

8.2 LED blinking pattern

The state of the corresponding LED (on/off) is shown over time.

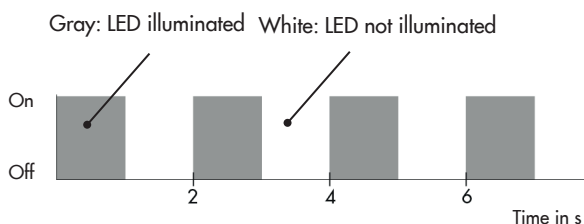

Operation

Blinking pattern of the yellow LED

- Device OFF

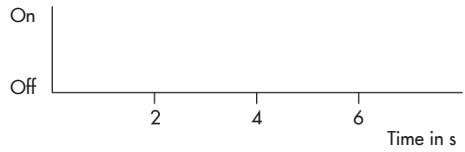

- Device ON

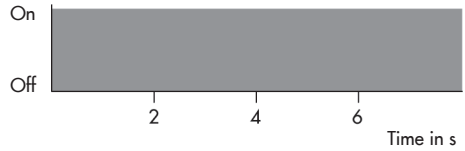

Blinking pattern of the red LED

- Device OFF or in normal operation

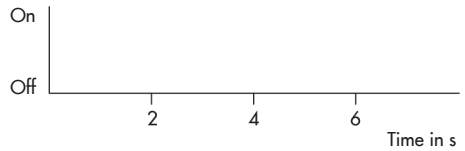

- Device starting up

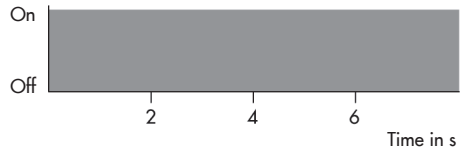

- Zero calibration in progress

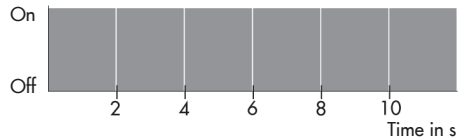

- Transit time measurement in progress

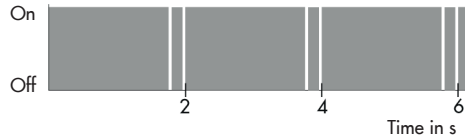

i Note

The blinking patterns for error indication are listed in the 'Malfunctions' section.

8.3 Change set point at the device

The set point can be adjusted manually at the set point potentiometer.

The adjustment range is between 10 and 100 % of the measuring range set in TROVIS-VIEW.

! NOTICE

Risk of electric shock from exposed live parts.

→ Do not touch live parts on operating the set point potentiometer.

Default setting:

Lower measuring range value $X_{min} = 0\text{ °C}$

Upper measuring range value $X_{max} = 100\text{ °C}$

In the delivered state, the set point potentiometer is set to 0 %, i.e. it does not have any effect on the selected W1 and W2 set points.

The manually adjusted value is only used for control if the function block F12 in TROVIS-VIEW is set to '1' (Automatic set point potentiometer: 'Manual adjustment effective above 10 %'). The required setting F12 - 1 is the default setting.

1. Open front cover.

! NOTICE

Risk of damage to the screw heads on the front cover due to the use of the wrong tool.

→ To screw or unscrew the screws, only use TORX® T10, TORX PLUS® 10IP or a flat-blade screwdriver with 0.8 mm blade thickness and 4.0 mm blade width.

2. Set the set point as required at the set point potentiometer.

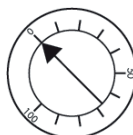

Setting range: 0 to 100 % of the measuring range (default setting 0 to 100 °C)

Do not forget to check the automatic set point potentiometer function.

i Note

Any setting below 10 % at the set point potentiometer is ignored by the controller. The controller uses the set point selected from the parameter list (TROVIS-VIEW software) for control.

Any setting above 10 % at the set point potentiometer is used by the controller for control. The set points entered into the parameter list are ignored.

3. Close front cover.

8.4 Manual mode

The actuator stem can be moved mechanically or alternatively electrically in the manual level in TROVIS-VIEW (► EB 6661).

i Note

A manual adjustment of the stem position only makes sense when the power supply is switched off as the stem position is determined by the actuator in closed-loop operation, meaning any manual adjustment would be automatically corrected by the actuator.

Direction of rotation

- Turn clockwise: the actuator stem extends (see Fig. 8-1).
- Turn counterclockwise: the actuator stem retracts (see Fig. 8-1).

! NOTICE

Risk of damage to the actuator by turning it too far.

- Only turn the handwheel far enough to move the actuator to the end position at the maximum.

8.4.1 Mechanical override

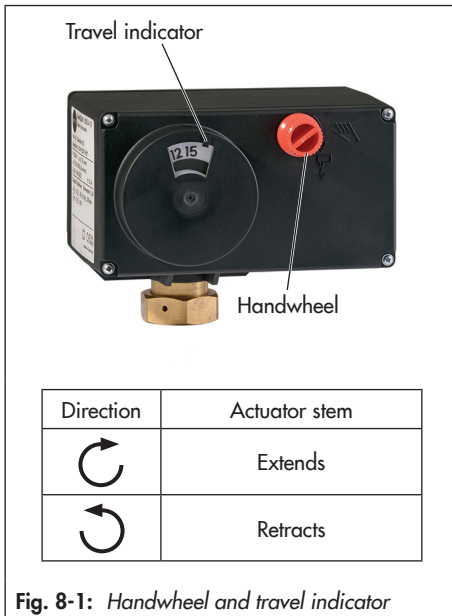

Fig. 8-1: Handwheel and travel indicator

TROVIS 5724-3

Changing the stem position at the handwheel:

- Switch off the supply voltage.
- Turn clockwise to extend the actuator stem (approx. 4 turns for 1 mm travel).
- Turn counterclockwise to retract the actuator stem (approx. 4 turns for 1 mm travel).

TROVIS 5725-3

The front cover must be opened before manually adjusting the actuator stem. The stem can be moved manually one millimeter by turning the actuating shaft approx. 4 turns using a 4 mm Allen key.

! NOTICE

Risk of electric shock from exposed live parts.

- Do not touch live parts on operating the manual override.



Fig. 8-2: Actuating shaft

1. Unscrew front cover and place a 4 mm Allen key on the red actuating shaft.
2. Use the Allen key to turn the actuating shaft:
 - Only turn counterclockwise for actuators with fail-safe action.

i Note

Turn only as far as the end position, which is at the point where the torque-dependent limit switch is activated.

- Once the magnet has been released, the spring mechanism pushes the actuator stem back to the fail-safe position.
3. Remove Allen key and carefully refasten the front cover.

8.5 Operation using memory pen

See ► EB 6661.

The memory pen can be loaded with data configured in TROVIS-VIEW and the configuration data transferred to one or several devices of the same type and version.

Additionally, the data from the device can be written to the memory pen. This allows the configuration data to be simply copied from one device and loaded onto other devices of the same type and version.

i Note

On inserting a memory pen that is empty or that contains data from another type of device or another version of the same device into the serial interface port of the actuator, the data from the actuator are uploaded to the memory pen regardless of the status of the memory pen and any other data on the memory pen will be overwritten.

Operation

Blinking pattern of the yellow LED

- Command mode

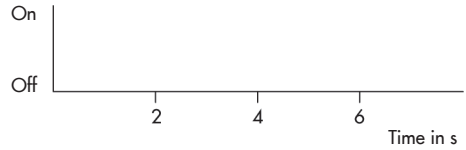

- Memory pen action completed

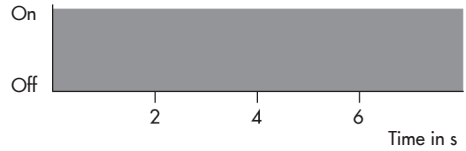

- Preparing to read from memory pen

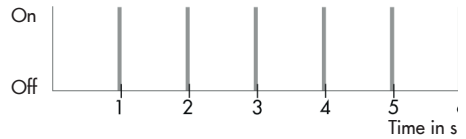

- Preparing to write data to memory pen

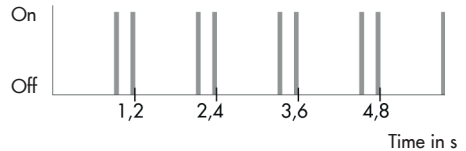

- Preparing data logging

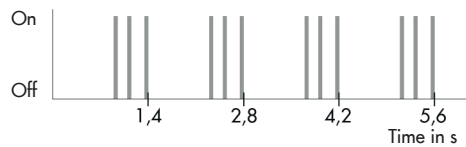

- Data logging in progress

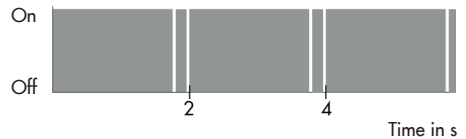

Blinking pattern of the red LED

- Memory pen inserted

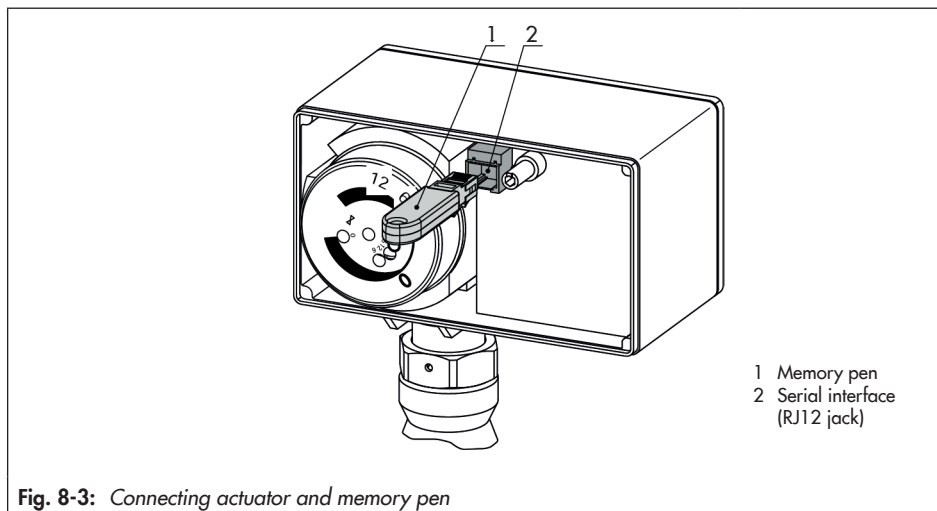
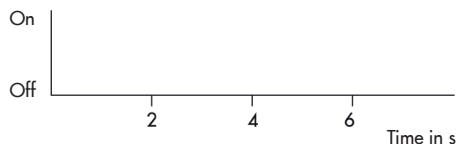

Fig. 8-3: Connecting actuator and memory pen

Data transmission between the actuator and memory pen

The memory pen is connected to the actuator as shown in Fig. 8-3. Refer to the TROVIS-VIEW Operating Instructions ► EB 6661 on how to transfer data.

The yellow LED on the actuator indicates that the data logging is being prepared. Data transmission is completed when the yellow LED is illuminated continuously.

8.5.1 Copying function

The memory pen can be used to copy setting data to other TROVIS 5724-x Actuators after the data from the actuator have been transferred to the memory pen.

i Note

“Automatically write to memory pen” is automatically reset to the read status after data are transferred from the actuator for the first time.

8.5.2 Command mode

In closed-loop operation, the actuator stem can be moved to the top or bottom end position using the command pen regardless of the control conditions.

Possible settings:

- No command
- Retract actuator stem
- Extend the actuator stem

8.6 Readings in TROVIS-VIEW

8.6.1 Operating values

i Note

The values in the 'Operating values' folder cannot be changed.

In **online mode**, the current operating values are listed in the 'Operating values' folder. Depending on the basic setting, a graph is shown under the 'Operating values' window.

8.6.2 Operating states

Error messages can be read in the 'Service' folder ('Operating states').

i Note

Operating states and errors are also indicated by the LEDs (see section 8.2 and the 'Malfunctions' section).

8.6.3 Functions

In the 'Service' folder ('Functions'), the following functions are shown:

Manual level	→ Manual level
Functions	→ Perform reset
	→ Load default settings in actuator
	→ Start zero calibration
	→ Start transit time measurement

The functions can be executed when communication between the actuator and computer is established.

8.6.4 Status messages

In the 'Service' folder ('Status messages'), device and operation parameters are shown:

Actuator	Firmware version	
	Serial number	
	Device information	
	Manufacturing parameters	
Operation	Operating hours	in h
	Operating hours at excess temperature	in h
	Temperature inside device	in °C
	Highest temperature inside device	in °C
	Lowest temperature inside device	in °C
Actuator strokes	Motor running time	in h
	Attempts	
	Changes in direction	
Valve strokes	Travel cycles	
LEDs	Yellow	
	Red	

8.6.5 Statistics

In the 'Service folder' ('Statistics'), various readings of counters are shown:

Device failures counters	Supply voltage activated
	Program interruptions
	Limit contact error
	EEPROM error
Alarms counters	Signal failure at the temperature input
	Signal failure at the current input
	Flow rate exceeds measuring range
	Upper limit GWH exceeded
Binary signals counters	Binary input activated
	Switching output activated
	Manual set point activated
	Tapping
Memory pen counters	Command retract stem
	Command extend stem
	Data read
	Data written
	Data logged
Functions counter	Settings changed
	Manual level activated
	Zero calibration started
	Reset triggered
	Default settings loaded
	Transit time measurement started

9 Malfunctions

9.1 Troubleshooting

→ Troubleshooting (see Table 9-1).

i Note

Contact our after-sales service for malfunctions not listed in the table.

Table 9-1: Troubleshooting

Error	Possible reasons	Recommended action
Actuator or plug stem does not move on demand.	Actuator is blocked.	→ Check attachment. → Remove the blockage.
	No or incorrect supply voltage connected.	→ Check the supply voltage and connections.
Actuator or plug stem does not move through the whole range.	No or incorrect supply voltage connected.	→ Check the supply voltage and connections.
The electric actuator with process controller does not perform the functions as required.	The configuration of the electric actuator does not meet the application requirements.	→ Check configuration. → If necessary, refer to the Configuration Manual ▶ KH 5724.
	The electric actuator was reset to its default settings without adapting the configuration to the application afterwards.	

9.2 Error indication by LEDs

Blinking pattern of the yellow LED

- Plausibility error in memory pen
- EEPROM error in memory pen

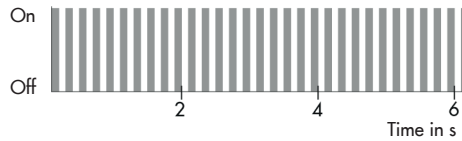
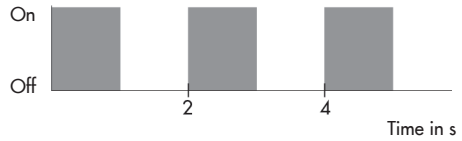

Blinking pattern of the red LED

- Temperature too high (upper limit (GWH) exceeded)
- EEPROM error in device
- Wire breakage at temperature input
- Wire breakage at current input

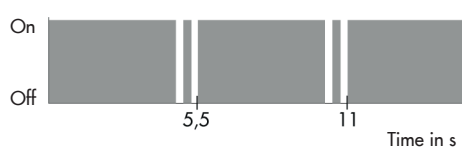
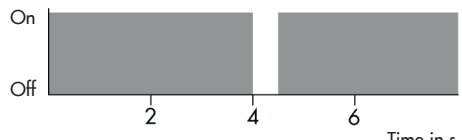
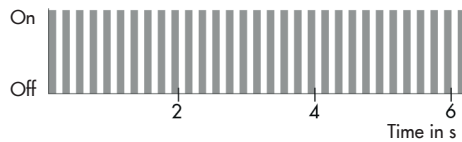
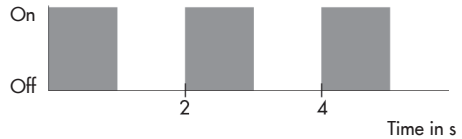

- Flow rate at water flow sensor exceeds measuring range

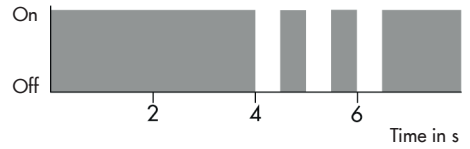

9.3 Emergency action

Plant operators are responsible for emergency action to be taken in the plant.



Tip

Emergency action in the event of valve failure is described in the associated valve documentation.

10 Servicing

The work described in this section is only to be performed by personnel appropriately qualified to carry out such tasks.

i Note

The electric actuator with process controller was checked by SAMSON before it left the factory.

– The product warranty becomes void if service or repair work not described in these instructions is performed without prior agreement by SAMSON's After-sales Service.

The actuator requires no maintenance.

We recommend inspection and testing according to Table 10-1.

Table 10-1: *Recommended inspection and testing*

Inspection and testing	Action to be taken in the event of a negative result
Check the markings, labels and nameplates on the electric actuator for their readability and completeness.	→ Immediately renew damaged, missing or incorrect nameplates or labels.
	→ Clean any inscriptions that are covered with dirt and are illegible.
Check the electric wiring.	→ Tighten any loose terminal screws (see the 'Installation' section).
	→ Renew damaged wires.

11 Decommissioning

The work described in this section is only to be performed by personnel appropriately qualified to carry out such tasks.

DANGER

Risk of fatal injury due to electric shock.

- Before disconnecting the wires at the actuator, switch off the supply voltage and protect it against unintentional reconnection.

WARNING

Risk of personal injury due to residual process medium in the valve.

While working on the valve, residual medium can flow out of the valve and, depending on its properties, cause personal injury, e.g. (chemical) burns.

- Wear protective clothing, safety gloves and eye protection.

WARNING

Risk of burn injuries due to hot or cold components and pipeline.

Valve components and the pipeline may become very hot or cold. Risk of burn injuries.

- Allow components and pipelines to cool down or warm up to the ambient temperature.
- Wear protective clothing and safety gloves.

To decommission the electric actuator for maintenance work or disassembly, proceed as follows:

- Put the control valve out of operation. See associated valve documentation.
- Disconnect the supply voltage and protect it against unintentional reconnection.

12 Removal

The work described in this section is only to be performed by personnel appropriately qualified to carry out such tasks.

⚠ DANGER

Risk of fatal injury due to electric shock.

→ Before disconnecting the wires at the actuator, switch off the supply voltage and protect it against unintentional reconnection.

⚠ DANGER

Risk of bursting in control valve components due to incorrect opening.

→ Before starting any work on the control valve, depressurize all plant sections affected as well as the valve.

→ Drain the process medium from all the plant sections affected.

→ Wear recommended personal protective equipment (see associated valve documentation).

12.1 Force-locking attachment

1. Open front cover.
2. Disconnect and remove the wires of the connection cables from the terminals.
3. Retract the actuator stem using the hand-wheel (see the 'Operation' section).

i Note

Hold the actuating shaft of actuators with fail-safe action in place after retracting the actuator stem to prevent it from extending again.

4. Unscrew the coupling nut (2 in Fig. 12-1) and remove the actuator from the valve connection.

12.2 Form-fit attachment

1. Open front cover.
2. Disconnect and remove the wires of the connection cables from the terminals.
3. Unfasten the stem connector clamps (5 in Fig. 12-1) between the actuator stem and the plug stem.
4. Retract the actuator stem using the hand-wheel (see the 'Operation' section).

i Note

Hold the actuating shaft of actuators with fail-safe action in place after retracting the actuator stem to prevent it from extending again.

5. Undo the nut (6 in Fig. 12-1) and remove the rod-type yoke (4 in Fig. 12-1) together with the actuator from the valve.
6. Undo the coupling nut (2 in Fig. 12-1) and remove the actuator from the rod-type yoke (4 in Fig. 12-1).

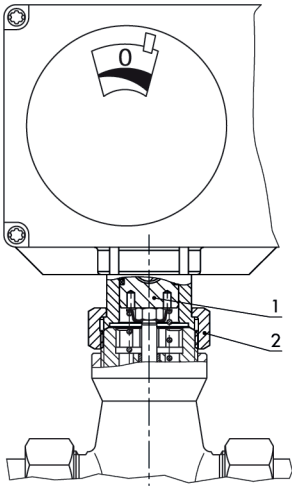

Force-locking attachment with coupling nut,
e.g. to Type 3222 Valve

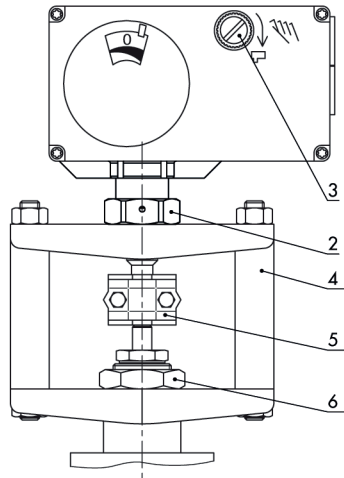

Form-fit attachment with stem connector, e.g.
with rod-type yoke on Series V2001 Valve

- 1 Actuator stem
- 2 Coupling nut
- 3 Handwheel (TROVIS 5724-3 only)

- 4 Rod-type yoke
- 5 Stem connector
- 6 Nut

Fig. 12-1: Attaching actuator and valve

13 Repairs

If the electric actuator does not function properly according to how it was originally configured or does not function at all, it is defective and must be exchanged.

! NOTICE

Risk of actuator damage due to incorrect service or repair work.

- *Do not perform any repair work on your own.*
 - *Contact SAMSON's After-sales Service.*
-

13.1 Returning the actuator to SAMSON

Defective actuators can be returned to SAMSON for examination.

Proceed as follows to return devices:

1. Remove the electric actuator from the valve (see the 'Removal' section).
2. Continue as described on our website at
 - ▶ www.samsongroup.com > Service & Support > After-sales Service > Returning goods .

14 Disposal



SAMSON is a producer registered at the following European institution
▶ <https://www.ewrn.org/national-registers/national-registers>.
WEEE reg. no.:
DE 62194439/FR 025665

- Observe local, national and international refuse regulations.
- Do not dispose of components, lubricants and hazardous substances together with your other household waste.

i Note

We can provide you with a recycling passport according to PAS 1049 on request. Simply e-mail us at aftersaleservice@samsongroup.com giving details of your company address.

Tip

On request, we can appoint a service provider to dismantle and recycle the product.

15 Certificates

The following certificates are included on the next pages:

- EU declarations of conformity
- TR CU certificate
- Declaration of incorporation

The certificates shown were up to date at the time of publishing. The latest certificates can be found on our website:

▶ www.samsongroup.com > Products & Applications > Product selector > Actuators > 5724-3

▶ www.samsongroup.com > Products & Applications > Product selector > Actuators > 5725-3

EU declaration of conformity for TROVIS 5724-3

SMART IN FLOW CONTROL



SAMSON

**EU Konformitätserklärung / EU Declaration of Conformity /
Déclaration UE de conformité**

Die alleinige Verantwortung für die Ausstellung dieser Konformitätserklärung trägt der Hersteller/
This declaration of conformity is issued under the sole responsibility of the manufacturer/
La présente déclaration de conformité est établie sous la seule responsabilité du fabricant.
Für das folgende Produkt / For the following product / Nous certifions que le produit

**Kombinierter Regler mit Hubantrieb / Controller with Electric Actuator /
Régulateur avec servomoteur électrique
Typ/Type/Type 5724**

wird die Konformität mit den einschlägigen Harmonisierungsrechtsvorschriften der Union bestätigt/
the conformity with the relevant Union harmonisation legislation is declared with/
est conforme à la législation d'harmonisation de l'Union applicable selon les normes:

EMC 2014/30/EU	EN 61000-6-2:2005, EN 61000-6-3:2010 +A1:2011
LVD 2014/35/EU	EN 60730-1:2016, EN 61010-1:2010
RoHS 2011/65/EU	EN 50581:2012

Hersteller / Manufacturer / Fabricant:

SAMSON AKTIENGESELLSCHAFT
Weismüllerstraße 3
D-60314 Frankfurt am Main
Deutschland/Germany/Allemagne

Frankfurt / Francfort, 2017-07-29
Im Namen des Herstellers/ On behalf of the Manufacturer/ Au nom du fabricant.

i.V. Gert Nahler
Gert Nahler
Zentralabteilungsleiter/Head of Department/Chef du département
Entwicklung Automation und Integrationstechnologien/
Development Automation and Integration Technologies

i.V. H. Zager
Hanno Zager
Leiter Qualitätssicherung/Head of Quality Management/
Responsable de l'assurance de la qualité

SAMSON AKTIENGESELLSCHAFT
Weismüllerstraße 3 60314 Frankfurt am Main

Telefon: 069 4009-0 · Telefax: 069 4009-1507
E-Mail: samson@samson.de

Revision 07

ca_5724-0_de_en_fr_en07.pdf

EU declaration of conformity for TROVIS 5725-3

SMART IN FLOW CONTROL



**EU Konformitätserklärung / EU Declaration of Conformity /
Déclaration UE de conformité**

Die alleinige Verantwortung für die Ausstellung dieser Konformitätserklärung trägt der Hersteller/
This declaration of conformity is issued under the sole responsibility of the manufacturer/
La présente déclaration de conformité est établie sous la seule responsabilité du fabricant.
Für das folgende Produkt / For the following product / Nous certifions que le produit

**Kombinierter Regler mit Hubantrieb / Controller with Electric Actuator /
Régulateur avec servomoteur électrique
Typ/Type/Type 5725**

wird die Konformität mit den einschlägigen Harmonisierungsrechtsvorschriften der Union bestätigt /
the conformity with the relevant Union harmonisation legislation is declared with/
est conforme à la législation d'harmonisation de l'Union applicable selon les normes:

EMC 2014/30/EU	EN 61000-6-2:2005, EN 61000-6-3:2010 +A1:2011
LVD 2014/35/EU	EN 60730-1:2016, EN 61010-1:2010
RoHS 2011/65/EU	EN 50581:2012

Hersteller / Manufacturer / Fabricant:

SAMSON AKTIENGESELLSCHAFT
Weismüllerstraße 3
D-60314 Frankfurt am Main
Deutschland/Germany/Allemagne

Frankfurt / Francfort, 2017-07-29

Im Namen des Herstellers/ On behalf of the Manufacturer/ Au nom du fabricant.

i.V. Gert Nahler

Gert Nahler
Zentralabteilungsleiter/Head of Department/Chef du département
Entwicklung Automation und Integrationstechnologien/
Development Automation and Integration Technologies

i.v. H. Zager

Hanno Zager
Leiter Qualitätssicherung/Head of Quality Management/
Responsable de l'assurance de la qualité

ca_5725-0_uk_en_10_rev07.pdf

SAMSON AKTIENGESELLSCHAFT
Weismüllerstraße 3 60314 Frankfurt am Main

Telefon: 069 4009-0 · Telefax: 069 4009-1507
E-Mail: samson@samson.de

Revision 07

ЕВРАЗИЙСКИЙ ЭКОНОМИЧЕСКИЙ СОЮЗ

СЕРТИФИКАТ СООТВЕТСТВИЯ



№ ЕАЭС RU C-DE.3A11.B.00049/19

Серия **RU** № **0197358**

ОРГАН ПО СЕРТИФИКАЦИИ Общества с ограниченной ответственностью «ТМС РУС».
 Место нахождения (адрес юридического лица): Российская Федерация, 127083, город Москва, улица Верхняя Масловка, дом 20, строение 2; адрес места осуществления деятельности: Российская Федерация, 127083, город Москва, улица Верхняя Масловка, дом 20, строение 2, помещения № 18, 28. Аттестат аккредитации № РОСС RU.0001.113A11 от 02.07.2015. Номер телефона: +7 (495) 221-18-04; адрес электронной почты: info@tms-cs.ru.

ЗАЯВИТЕЛЬ Общество с ограниченной ответственностью «Самсон Контролс».
 Место нахождения (адрес юридического лица) и адрес места осуществления деятельности: Российская Федерация, город Москва, бульвар Энтузиастов, дом 2, этаж 5, комната 11. ОГРН 1037700041026. Номер телефона: +7 (495) 777-45-45; адрес электронной почты: samson@samson.ru.

ИЗГОТОВИТЕЛЬ «SAMSON AG Mess- und Regellechnik».
 Место нахождения (адрес юридического лица) и адрес места осуществления деятельности по изготовлению продукции: Weismüllerstrasse 3, D-60314 Frankfurt am Main, Германия.

ПРОДУКЦИЯ Приводы электрические типы 3274, 3374, 3375, 5724, 5725, 5757, 5824, 5825, 5857.
 Изготовление в соответствии со стандартами, указанными в приложении к сертификату соответствия на бланке № 0676634.
 Серийный выпуск.

КОД ТН ВЭД ЕАЭС 8501 10 930 0

СООТВЕТСТВУЕТ ТРЕБОВАНИЯМ технических регламентов Таможенного союза «О безопасности низковольтного оборудования» (ТР ТС 004/2011); «Электромагнитная совместимость технических средств» (ТР ТС 020/2011)

СЕРТИФИКАТ СООТВЕТСТВИЯ ВЫДАН НА ОСНОВАНИИ протоколов сертификационных испытаний № Г608-5418, Г608-5419, Г608-5420 от 18.09.2019, выданных Испытательной лабораторией Ассоциации экспертов по сертификации и испытаниям продукции «Сертификационный центр НАСТХОЛ», аттестат аккредитации РОСС RU.0001.21Г606; № 190919-004-008-02/ИР от 24.10.2019, выданных Испытательной лабораторией Общества с ограниченной ответственностью «Инновационные решения», аттестат аккредитации РОСС RU.0001.21AB90; акта о результатах анализа состояния производства № 00062-A от 04.07.2019 органа по сертификации Общества с ограниченной ответственностью «ТМС РУС»; руководств по эксплуатации 3428-ЭП-2019.РЭ, 3428-5720-5750-2018.РЭ. Схема сертификации – 1с.

ДОПОЛНИТЕЛЬНАЯ ИНФОРМАЦИЯ Стандарты, в результате применения которых, на добровольной основе обеспечивается соблюдение требований технических регламентов: ГОСТ 12.2.007-0-76 «Система стандартов безопасности труда. Изделия электротехнические. Общие требования безопасности; раздел 8 ГОСТ 30804.6.2-2013 «Совместимость технических средств электромагнитная. Устойчивость к электромагнитным помехам технических средств, применяемых в промышленных зонах»; раздел 7 ГОСТ 30804.6.4-2013 «Совместимость технических средств электромагнитная. Электромагнитная помехи от технических средств, применяемых в промышленных зонах». Назначенный срок службы – 12 лет. Назначенный срок хранения – 2 года. Условия хранения указаны в руководстве по эксплуатации 3428-ЭП-2019.РЭ, 3428-5720-5750-2018.РЭ.

СРОК ДЕЙСТВИЯ С 05.12.2019 **ПО** 04.12.2024

ВКЛЮЧИТЕЛЬНО

Руководитель (уполномоченное лицо) органа по сертификации _____ (подпись)

Эксперт (эксперт-аудитор) _____ (подпись)

Эксперт (эксперт-аудитор) _____ (подпись)



Ванькова Евгения Владимировна (Ф.И.О.)

М.П.

Ходоров Владимир Игоревич (Ф.И.О.)

АО «Самсон», Москва, 2019 г. «С». Лицензия № 05-05-05-003 ФНС РФ. ТЭ № 368. Тел.: (495) 726-47-42, www.samson.ru

ЕВРАЗИЙСКИЙ ЭКОНОМИЧЕСКИЙ СОЮЗ

ПРИЛОЖЕНИЕ

К СЕРТИФИКАТУ СООТВЕТСТВИЯ № ЕАЭС RU C-DE.ЭА11.В.00049/19

Серия **RU** № **0676634** Лист 1 из 1

Стандарты, в соответствии с которыми изготавливается продукция

Обозначение стандарта	Наименование стандарта
IEC 60730-1:2013 / Cor. 1:2014	Automatic electrical controls for household and similar use. Part 1. General requirements. Corrigendum 1
EN 61000-6-1:2007	Electromagnetic compatibility (EMC) - Part 6-1: Generic standards - Immunity for residential, commercial and light-industrial environments
IEC 61000-6-2:2016	Electromagnetic compatibility (EMC). Part 6-2: Generic standards. Immunity for industrial environments
EN 61000-6-3:2007 + A1:2011	Electromagnetic compatibility (EMC). Part 6-3: Generic standards. Emission standard for residential, commercial and light-industrial environments
IEC 61010-1:2010	Safety requirements for electrical equipment for measurement, control, and laboratory use. Part 1: General requirements
EN 61326-1:2013	Electrical equipment for measurement, control and laboratory use. EMC requirements. Part 1: General requirements

Руководитель (уполномоченное лицо) органа по сертификации

Эксперт (эксперт-аудитор) (эксперты (эксперты-аудиторы))

[Handwritten signature]
(подпись)



Ванькович Евгения Владимировна (Ф.И.О.)

Ходоров Владимир Игоревич (Ф.И.О.)

Declaration of incorporation

EINBAUERKLÄRUNG
ORIGINAL



Einbauerklärung nach Maschinenrichtlinie 2006/42/EG

Für folgendes Produkt:
Stellantrieb Typ 5724-3 / 5725-3

Wir, die SAMSON AG, erklären, dass der elektrische Stellantrieb Typ 5724-3 / 5725-3 eine unvollständige Maschine im Sinne der Maschinenrichtlinie 2006/42/EG ist und die sicherheitstechnischen Anforderungen nach Anhang I Artikel 1.1.2, 1.1.3, 1.1.5, 1.2.1, 1.2.2, 1.2.3, 1.2.5, 1.2.6, 1.3.1, 1.3.2, 1.3.3, 1.3.4, 1.3.7, 1.3.8.2, 1.3.9, 1.4.1, 1.5.3, 1.5.4 und 1.5.8 der Richtlinie eingehalten werden. Die speziellen Unterlagen nach Anhang VII Teil B wurden erstellt.

Die Inbetriebnahme der von uns gelieferten Erzeugnisse darf nur erfolgen, wenn vorher festgestellt wurde, dass die Maschinen oder Anlagen, in die die Produkte eingebaut werden sollen, den Bestimmungen der EG-Maschinenrichtlinie 2006/42/EG entsprechen.

Der Anwender ist verpflichtet, das Erzeugnis den anerkannten Regeln der Technik und der Einbau- und Bedienungsanleitung entsprechend einzubauen und Gefährdungen, die am Stellventil vom Durchflussmedium und Betriebsdruck sowie vom Stelldruck und von beweglichen Teilen ausgehen können, durch geeignete Maßnahmen zu verhindern.

Die zulässigen Einsatzgrenzen und Montagehinweise der Geräte ergeben sich aus der entsprechenden Einbau- und Bedienungsanleitung und stehen im Internet unter www.samsongroup.com in elektronischer Form zur Verfügung.

Produktbeschreibung siehe:

- Elektrischer Antrieb Typ 5724-3 / 5725-3: Einbau- und Bedienungsanleitung EB 5724

Folgende technischen Normen und/oder Spezifikationen wurden angewandt:

- VCI/VDMA/VGB – Leitfaden Maschinenrichtlinie (2006/42/EG) – Bedeutung für Armaturen, Mai 2018
- VCI/VDMA/VGB – Zusatzdokument zum „Leitfaden Maschinenrichtlinie (2006/42/EG) – Bedeutung für Armaturen vom Mai 2018“, Stand Mai 2018 in Anlehnung an DIN EN ISO 12100:2011-03

Bemerkungen:

- Restgefahren siehe Angaben in der Einbau- und Bedienungsanleitung
- Weiterhin sind die in den Einbau- und Bedienungsanleitungen aufgeführten mitgeltenden Dokumente zu beachten.

Für die Zusammenstellung der technischen Unterlagen ist bevollmächtigt:

SAMSON AG, Weismüllerstraße 3, 60314 Frankfurt am Main, Germany
Frankfurt am Main, 11. August 2021

i.V. Stephan Giesen
Zentralabteilungsleiter
Produktmanagement

i.V. Sebastian Krause
Zentralabteilungsleiter
Strategische Entwicklung Ventile und Antriebe



Revision 00

Classification: Public · SAMSON AKTIENGESELLSCHAFT · Weismüllerstraße 3 · 60314 Frankfurt am Main

Seite 1 von 1

16 Annex

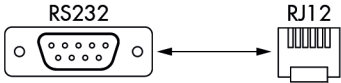
16.1 Accessories

Accessories	
Pt 1000 temperature sensor, fast response	Type 5207-0060
Sensor pocket G $\frac{3}{4}$	Order no. 1400-9249
Sensor pocket G 1	Order no. 1400-9252
Connecting piece G $\frac{3}{4}$	Order no. 1400-9236
Connecting piece G 1	Order no. 1400-9237
Circulation pipe connection	Order no. 1400-9232
Water flow sensor	Order no. 1400-9246
Hardware package consisting of: <ul style="list-style-type: none"> - Memory pen-64 - Connecting cable - Modular adapter 	Order no. 1400-9998
Memory pen-64	Order no. 1400-9753 
Connecting cable	Order no. 1400-7699 
Modular adapter	Order no. 1400-7698 
USB to RS232 adapter	Order no. 8812-2001 

Software	
TROVIS-VIEW (free of charge)	▶ www.samsongroup.com > Service & Support > Downloads > TROVIS-VIEW

16.2 After-sales service

Contact our after-sales service for support concerning service or repair work or when malfunctions or defects arise.

E-mail contact

You can reach our after-sales service at
▶ aftersalesservice@samsongroup.com.

Addresses of SAMSON AG and its subsidiaries

The addresses of SAMSON, its subsidiaries, representatives and service facilities worldwide can be found on our website (▶ www.samsongroup.com) or in all SAMSON product catalogs.

Required specifications

Please submit the following details:

- Type designation
- Material number
- Serial number
- Firmware version

16.3 Configuration and parameter list

Configuration list

The function blocks F01 to F14 have the following listed functions.

F = Function block WE = Default setting 0 = OFF, 1 = ON

F	Function	WE	Meaning
01	DHW tapping recognition	1	0: Continuous control 1: Flow rate sensor active
02	Flow rate sensor	1	0: Flow switch 1: Water flow sensor
03	Adaptation	1	0: Passive 1: Active (with water flow sensor)
04	Direction of action	0	0: >> (increasing/increasing) 1: << (increasing/decreasing)
05	Current input	0	0: Passive (binary input) 1: Active
06	Function of current input	0	0: Actual value 1: Set point
07	Measuring range of current input	0	0: 0 to 20 mA 1: 4 to 20 mA
08	Function of binary input	0	0: Termination of maintaining heat exchanger at constant temperature 1: Switchover between internal set points
09	Maintain heat exchanger at constant temperature	0	0: Time adjustable 1: Continuous
10	Upper limit (GWH)	0	0: No limitation 1: Exceeding GWH causes switch-off
11	Lower limit (GWL)	0	0: No frost protection 1: Violation of GWL causes frost protection to start
12	Manual set point	1	0: No manual adjustment 1: Manual adjustment effective above 10 %
16	Function of switching output	3	1: Passive 2: Fault alarm 3: Circulation pump (DHW) 4: Circulation pump (heating) 5: Tapping 6: Circulation pump (heating) reversed
17	Pump protection	1	0: No 1: Yes

Annex

Parameter list

The parameters have the setting ranges as listed below.

P = Parameter

WE = Default setting

P	Parameters	WE	Adjustment range
01	Set point W1	60 °C	0 Up to 100 °C
02	Set point W2	70 °C	0 Up to 100 °C
03	Lower measuring range value Xmin	0 °C	-50 Up to +90 °C
04	Upper measuring range value Xmax	100 °C	10 Up to 150 °C
05	Upper limit (GWH)	95 °C	0 Up to 100 °C
06	Lower limit (GWL)	5 °C	0 Up to 20 °C
07	Proportional-action coefficient KP	0.6	0.1 Up to 50
08	Reset time Tn	25 s	0 to 999 s
09	Derivative-action time Tv	0 s	0 to 999 s
10	Actuator transit time Ty	35 s	0 to 240 s
11	Set-back difference	8 K	0 to 30 K
12	Heating period to maintain heat exchanger at constant temperature	24 h	0.0 to 25.5 h

16.4 Customer-specific data

Station	
Operator	
SAMSON office	

Function blocks		
F	WE	Setting
01	1	
02	1	
03	1	
04	0	
05	0	
06	0	
07	0	
08	0	
09	0	
10	0	
11	0	
12	1	
16	3	
17	1	

Parameters			
P	WE	Setting	Adjustment range
01	60 °C		0 to 100 °C
02	70 °C		0 to 100 °C
03	0 °C		-50 to +90 °C
04	100 °C		10 to 150 °C
05	95 °C		0 to 100 °C
06	5 °C		0 to 20 °C
07	0.6		0.1 to 50
08	25 s		0 to 999 s
09	0 s		0 to 999 s
10	35 s		0 to 240 s
11	8 K		0 to 30 K
12	24 h		0.0 to 25.5 h

EB 5724 EN



SAMSON AKTIENGESELLSCHAFT

Weismüllerstraße 3 · 60314 Frankfurt am Main, Germany

Phone: +49 69 4009-0 · Fax: +49 69 4009-1507

samson@samsongroup.com · www.samsongroup.com