



Mounting and Operating Instructions

EB 6616 EN

Firmware version 1.30
Edition February 2016



Definition of signal words



DANGER!

Hazardous situations which, if not avoided, will result in death or serious injury



WARNING!

Hazardous situations which, if not avoided, could result in death or serious injury



NOTICE

Property damage message or malfunction



Note:

Additional information



Tip:

Recommended action

1	Important safety instructions	4
2	Overview of the TROVIS 6600 Automation System	4
2.1	Network expansion (without repeaters, hubs etc.)	5
2.2	Cable recommendation	5
2.3	Power supply	5
3	Notes concerning TROVIS 6616 Web Terminal	5
4	Technical data	6
5	Installation	7
6	Start-up	8
6.1	Restarting the Setup Wizard	10
6.2	Configuring Auto Start	12
7	Operation	13
7.1	Login	14
7.2	Main menu	15
7.3	Offline and online trends	15
7.3.1	Historical data (offline trend).....	15
7.3.2	Online data (online trend).....	17
7.3.3	Configuring the target directory	18
7.4	Active alarms	20
7.5	Service page	20
7.5.1	I/O View web application	21
7.6	Time program	21
7.6.1	Adding switching times	21
7.6.2	Changing switching times	23
7.6.3	Deleting switching times	25
7.6.4	Creating special schedules	26
8	TROVIS MOBILE	28
9	Cleaning the screen	30

1 Important safety instructions

- The web terminal is to be mounted, started up or operated only by trained and experienced personnel familiar with the product. According to these mounting and operating instructions, trained personnel refers to individuals who are able to judge the work they are assigned to and recognize possible dangers due to their specialized training, their knowledge and experience as well as their knowledge of the applicable standards.
- The web terminal is designed for use in low voltage installations. For wiring and maintenance, you are required to observe the relevant safety regulations.
- Proper shipping and storage are assumed.

2 Overview of the TROVIS 6600 Automation System

The TROVIS 6616 Web Terminal is an optional component of the TROVIS 6600 Automation System and is used in conjunction with a TROVIS 6610 CPU Module and is suitable for mounting in switching cabinet panels. The user can view operating data on site on the touch screen, change set points and parameters as well as access time schedules of a building automation system.

The web terminal runs as a web client under the Android operating system. Graphic visualization saved in the web server in TROVIS 6610 can be accessed using a Java-enabled browser. An unlimited number of TROVIS 6616 web terminals can be connected to a CPU module.

The TROVIS 6616 Web Terminal allows access to the visualization of several TROVIS 6610 CPU Modules. All plant schemes are saved in the TROVIS 6610 CPU Module. The web terminal can be used to view, for example, colored plant schemes with dynamically refreshed values. Data, such as set points, time programs etc., can be conveniently changed on the touch screen.

The alarm list shows recorded events in chronological order with a comment.

Online or historical data can be viewed on the TROVIS 6616 Web Terminal and saved to CSV files for further processing to an external device, which can be plugged into the USB port. Alternatively, the text-based operator interface of TROVIS Mobile can be used.

Associated software

Operating system	Android 4.0.3 with browser Part of TROVIS 6616 Web Terminal
Application	Microbrowser for Android version 1.6.30.142 and higher
Graphical project management tool	TROVIS 6690 (not included in the scope of delivery)
Web Terminal Editor	TROVIS 6693 (not included in the scope of delivery)

2.1 Network expansion (without repeaters, hubs etc.)

Ethernet	100BaseT typ. LAN
----------	-------------------

2.2 Cable recommendation

24 V AC	1.5 mm ² stranded wire
Ethernet	Min. Cat 5 cable, shielded (STP)

2.3 Power supply

24 V DC or Power over Ethernet (PoE)

3 Notes concerning TROVIS 6616 Web Terminal

The TROVIS 6616 Web Terminal can only be used in conjunction with a TROVIS 6610 CPU Module.

A project must be saved in the TROVIS 6610 CPU Module configured using the TROVIS 6690 Graphical Project Management Tool. This project requires a web application created using the TROVIS 6693 Web Terminal Editor or a TROVIS Mobile web application created using the TROVIS 6690 Graphical Project Management Tool.

4 Technical data

Power supply	
Power supply	24 V DC or Power over Ethernet (PoE)
Power consumption	7.4 W
PE	a) Wire cross-section stranded with ferrule without plastic sleeve, max. 1.5 mm ² b) Wire cross-section stranded with ferrule with plastic sleeve, max. 0.5 mm ²
Temperature range	
Operation	0 to 50 °C
Transportation and storage	0 to 70 °C
Relative humidity	10 to 90 %, non-condensing
Electromagnetic compatibility	
Noise emission	According to EN 61000-6-3
Noise immunity	According to EN 61000-6-2
Device safety	
Class of protection	II according to EN 61140: 2003
Overvoltage category	II according to EN 60664-1
Degree of contamination	2 according to EN 60664-1
Degree of protection	IP 65 at the front, IP 20 at the back
CE	EN 55022: 2010 Class B EN 55024: 2010 EN 61000-6-2: 2005
Performance	
CPU	Cortex A8 processor with ultra low voltage, 1 GHz
RAM	512 MB LPDDR RAM
Display	7" widescreen LED-TFT monitor, projected capacitive touch screen
Resolution	800 x 480 pixels, can be used for microbrowser with 758 x 480 pixels
Interfaces	
USB	Two USB 2.0 A ports, one mini USB port
Ethernet 10/100 with 802.3af PoE (Power over Ethernet)	1 x RJ45
Compliance	CE · EAC

5 Installation

The web terminal is designed for panel mounting with the front dimensions 208 x 144 mm. Install as follows:

- ➔ Make panel cut-out with the dimensions 186 x 123 mm.
- ➔ Slide the web terminal from the front with the ventilation slits facing upward into the panel cut-out.
- ➔ Clamp the web terminal from the back against the control panel using the four supplied clips.

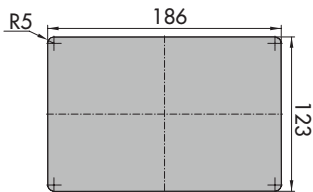

Fig. 1: Panel cut-out

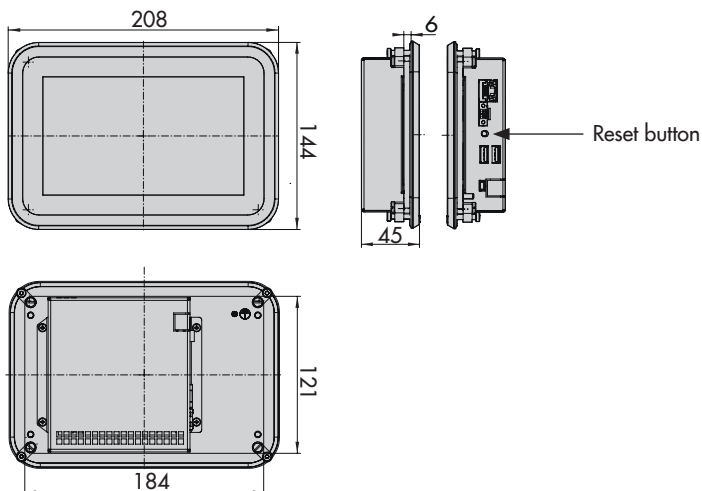

Fig. 2: Dimensions of TROVIS 6616 Web Terminal

6 Start-up

Observe the following instructions:

- Ethernet must be connected to the TROVIS 6610 CPU Module.
- The TROVIS 6616 Web Terminal and the TROVIS 6610 CPU Module must be configured using the same subnetwork.
- Ethernet can either be connected directly to the TROVIS 6610 CPU Module or over active components.

We recommend using a PoE (Power over Ethernet) switch. As a result, the external DC voltage supply for the TROVIS 6616 Web Terminal is not required.

- A cross cable must be used to directly connect the TROVIS 6616 to TROVIS 6610.
- To establish connection over active components (switch/hub), a 1:1 cable must be used. Refer to the manual of the components used for more information.

The SAMSON start screen appears approx. 25 seconds after the Ethernet connection is established. The Launcher starts automatically.

The Setup Wizard appears 15 seconds after the Launcher starts on starting for the first time.

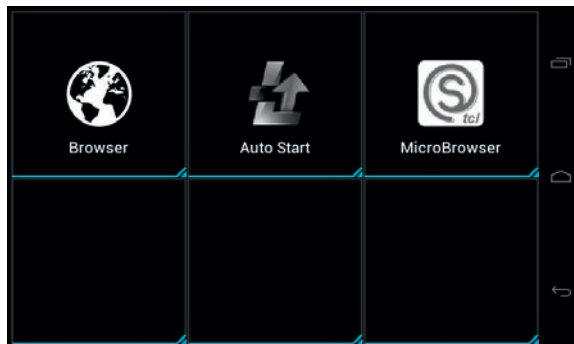

1. The web terminal has the default IP address 172.30.240.100/16. To change the IP address, open the IP Address field and enter a new IP address. Press [Done] to confirm.
2. The netmask, DNS and gateway configurations can be changed as described in step 1.
3. Start the FTP server, if it is not already activated, by checking the box.
4. Enter the IP address of the TROVIS 6610 CPU Module in the TROVIS 6610 field. This IP address is automatically entered in the host file so that the TROVIS 6610 CPU Module can be addressed by its host name "trovis6610"
5. Press [Save] to save the configuration.

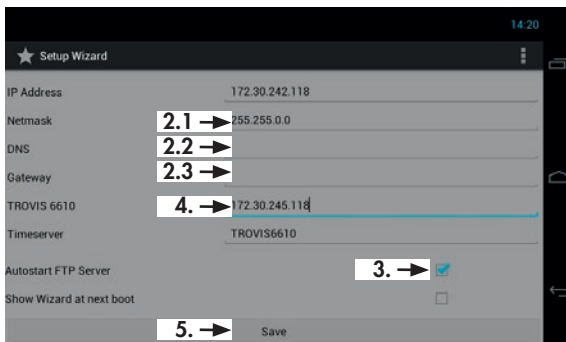
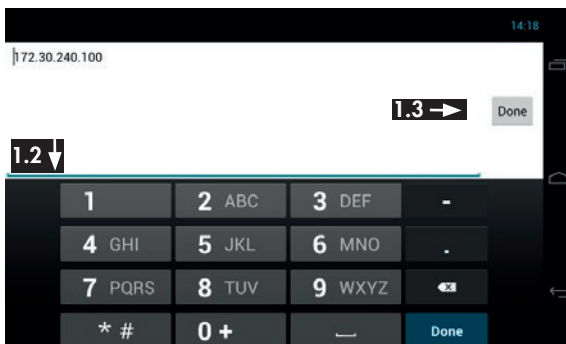
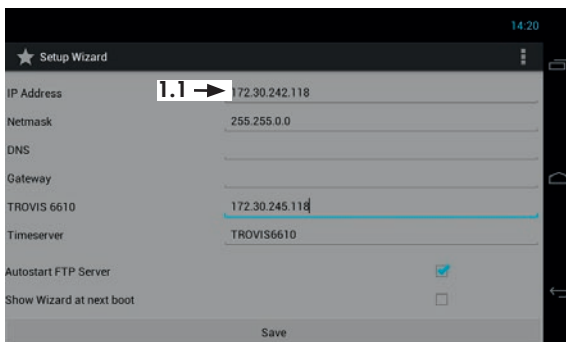

6. Reboot the web terminal:
Buttons:  and [Reboot]
7. Confirm "Reboot system?" with [OK].
8. Continue as described in section 6.2.

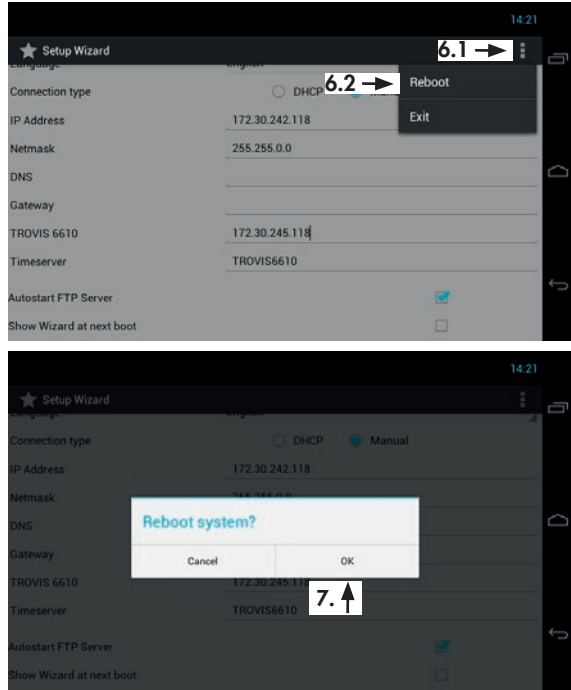

6.1 Restarting the Setup Wizard

1. Swipe the screen to the second page of the Launcher and select Settings.

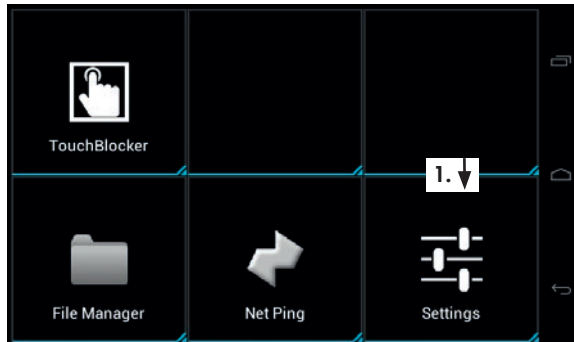

2. Press [Password] and enter the password using the number pad.

The password that is valid on the first start-up can be found on page 35. To avoid its unauthorized use, remove the page or make the password unreadable.

Press [Done] after entering the password and confirm with [OK].

3. Select [Start Wizard].
4. Change setup settings as described in the previous section. Press [Save].
5. Reboot the web terminal.

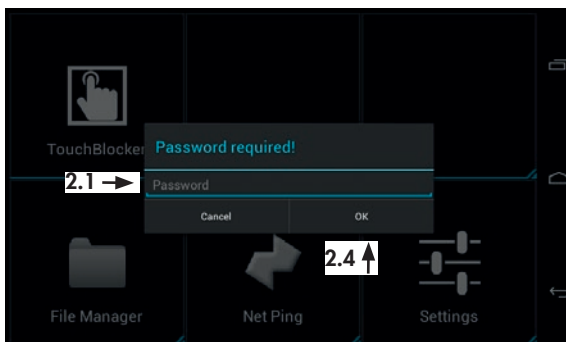

1732

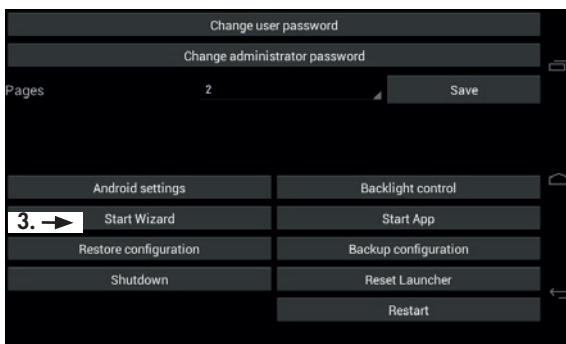
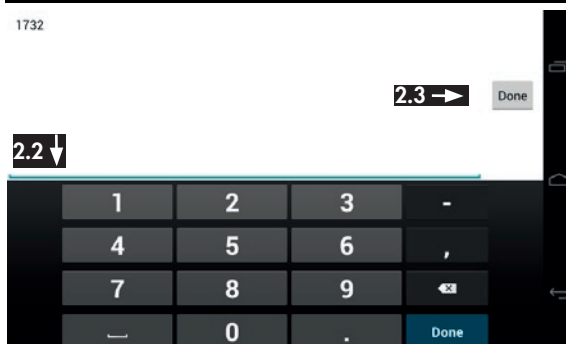

6.2 Configuring Auto Start

The application determined in Auto Start starts automatically on starting the web terminal.

1. Select [Auto Start] in the Launcher.
2. If the required application does not appear under "Application", e.g. MicroBrowser, press [Select] and select the required application.



Note:

To use the TROVIS MOBILE application instead of the MicroBrowser application, select "Browser".

3. Activate Auto Start by selecting "ON" with green background.
4. Exit configuration.
Buttons: and
5. Exit Auto Start by swiping up from the bottom of the screen.



Note:

If a different application other than one determined in Auto Start is to be started, this must be opened manually.

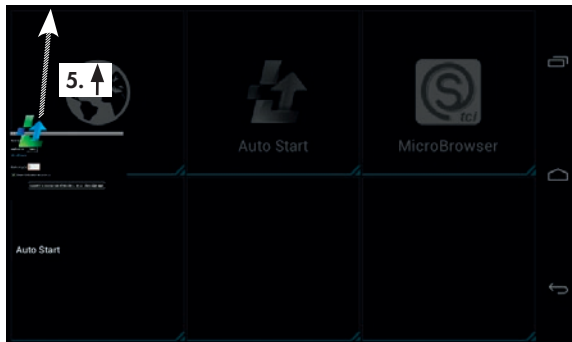
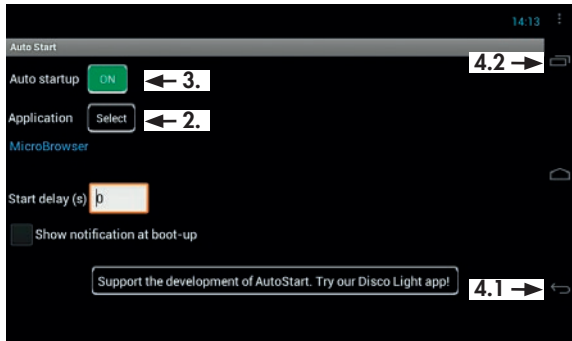
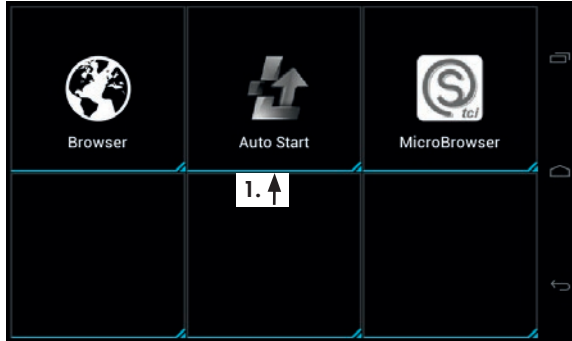

7 Operation

The start page appears when no users are logged in.



Status bar:

SAMSON AG

User level:









- 0 = Read only
- 1 = Read/write access
- 2 = Almost all privileges
- 3 = Administrator

AT = Outdoor temperature (optional)

Date

Time

Toolbar

-  = Back
-  = Open main menu
-  = Login status: not logged in
-  = Login status: logged in
Open login page
-  = Show historical data
-  = Show online data
-  = Show active alarms
-  = Open service page



Note:

Status bar and toolbar remain visible in most cases.

7.1 Login

- ➔ Enter password in "Enter password" field.
- ➔ Press OK.



Note:

The password determines which user level applies.



After logging in:



The login status changes to logged in.



The key indicates which user level is active.

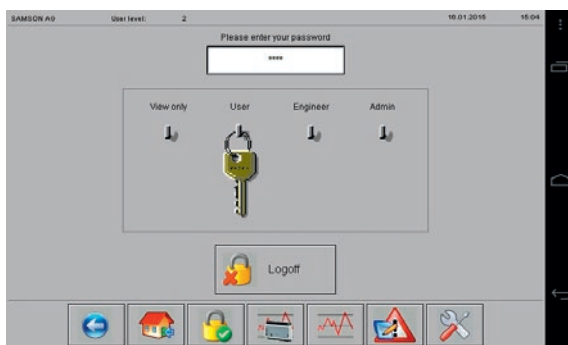

(only in user level 2 and 3)

Date and time of TROVIS 6610 CPU Module can be changed in user level 3 (almost all privileges) and 4 (administrator).



Logout before the time entered for automatic logout elapses.

7.2 Main menu

→ Open main menu.

Button (toolbar): 

The main menu of the master for the SAMSON TROVIS 6693 Web Terminal Editor is shown in this example.

If the system is made up of just one graphic, the plant image is directly shown after opening the main menu.

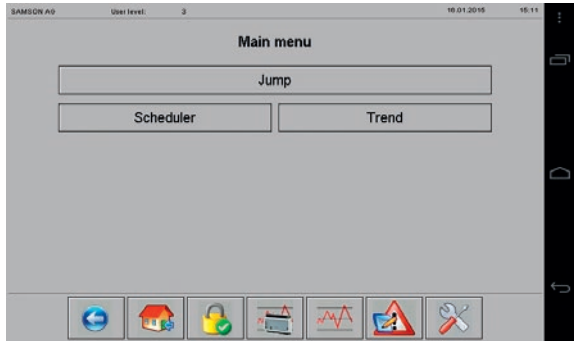

7.3 Offline and online trends

7.3.1 Historical data (offline trend)

→ Go to historical data.



Button (toolbar): 

Possible actions:

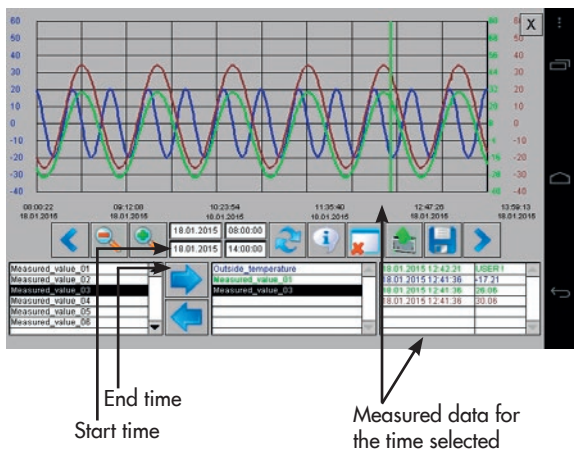

- View the course of a data point in a graph.
- Restrict the time period of the graph.
- Change how the graph is shown.
- Export data.
- Exit the graph.



Viewing the course of a data point in a graph

- Select the data point from the bottom left-hand list.
- Move the data point into the middle list.
Button: 
- Load the start and end dates of the data point into the corresponding data entry fields.
Button: 
- Load the data point into the graph. Button: 
The course of the data point between the start and end dates is plotted.

Restricting the time period of the graph





- Delete plotted data point.
This does not cause any data to be deleted in the CPU module.
Button: 
- Enter start and stop times and press OK.
Date format: DD.MM.YYYY
Time format: hh:mm:ss
- Confirm the start and stop times.
Button: 
- Load the data point into the graph. Button: 



Tip:

The plotted data point must only be deleted if the displayed time period needs to be shortened. If the time period between 22.10 and 28.10 has been selected, data for the time period between 21.10 and 28.10 can be displayed without having to delete the plotted data point first. However, if the data point is then to be displayed for the time period between 26.10 and 28.10, the plotted data point must be deleted beforehand.

Changing how the graph is displayed

- Shift displayed graph section to the right or left
Buttons:  / 
- Reduce/expand the graph
Buttons:  / 

Exporting data

- Save data in CSV format to the internal memory or to an external memory (USB flash drive). Button: 

Exiting the graph

- Return to the main menu.
Button: (top right) 

7.3.2 Online data (online trend)

- Show online data.

Data defined in the TROVIS 6693 Web Terminal Editor are shown. It is not possible to select other data on the web terminal.

Button (toolbar): 



Note:

Display range and logging time are determined when the web page is created in TROVIS 6693 Web Terminal Editor. The maximum data logging time is 25 hours.



The width of the graph is reduced by the automatic scaling of the Y axis when a lot of measured data exists.

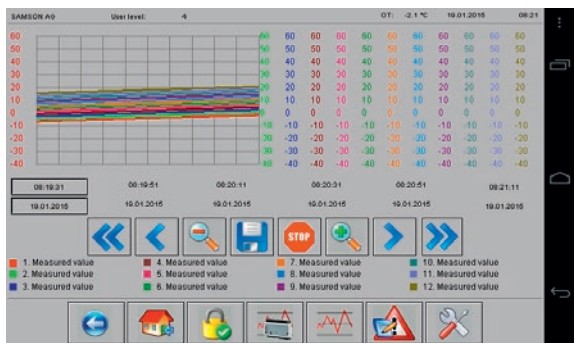

Alternatively, the automatic scaling of the Y axis can be deselected to make the graph larger.

Possible actions:

- Change how graph is displayed.
- Stop data logging.
- Export data.

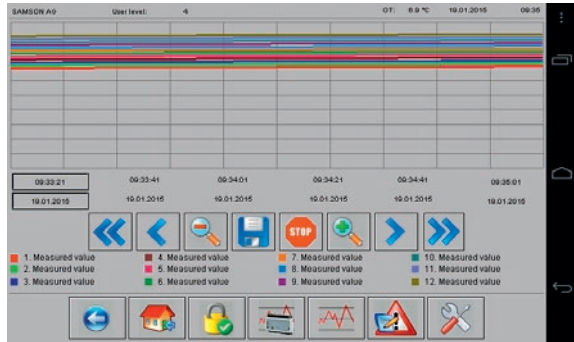

Changing how the graph is displayed

→ Shift displayed graph section to the right or left

Buttons:   /  

→ Reduce/expand the graph

Buttons:  / 

Stopping data logging

→ Stop/start data logging

Buttons:  / 

Exporting data

→ Save data in CSV format to the internal memory or to an external memory (USB flash drive).

Button: 

7.3.3 Configuring the target directory

The default directory for saving offline and online trend data is [/mnt/sdcard/Download] on the web terminal. Data can also be copied to a computer or USB flash drive.

Saving data to a computer

An FTP client (e.g. File Zilla) is required.

Login data:

Server: IP address of web terminal

User name: www



Password: 0725

Port: 2121

Copying data to a USB flash drive

1. Insert the USB flash drive into the side USB port.
2. Go to the login page.
3. Open the configuration menu.
4. Select "Options".
5. Select the [/mnt/usb_host] directory by checking the box.
6. Go to historical data or on-line data.

Button: 

Button:  or 

7. Save data.

Button: 

Before removing the USB flash drive:

- ➔ Repeat steps 1 to 4.
- ➔ Deselect [/mnt/usb_host] directory by unchecking the box.

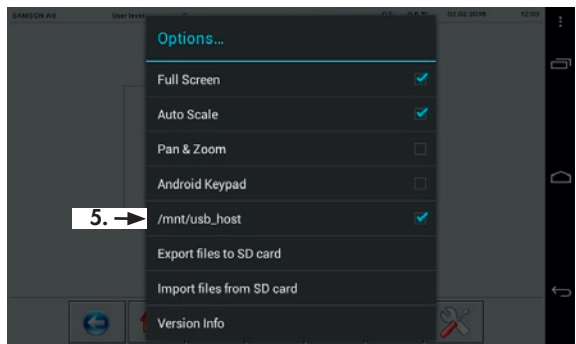

7.4 Active alarms

→ Show active alarms. Button (toolbar): 

The total number of active alarms as well as each individual alarm with the time and date of its activation are listed.

Alarms that are no longer valid are removed from the list without any additional information. The list starts with most recently generated alarm (TROVIS 6610 CPU Module with firmware 2.0 and higher).

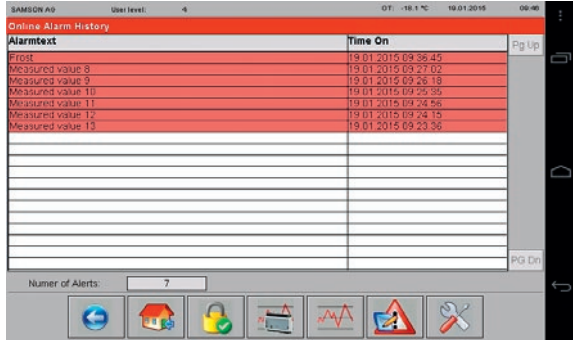

Alarmtext	Time On
Protst	19.01.2015 09:36:45
Measured value 8	19.01.2015 09:27:02
Measured value 9	19.01.2015 09:26:18
Measured value 10	19.01.2015 09:25:35
Measured value 11	19.01.2015 09:24:56
Measured value 12	19.01.2015 09:24:15
Measured value 13	19.01.2015 09:23:36

7.5 Service page



Note:

The service page can only be opened in user level 4 (administrator).

→ Open service page. Button (toolbar): 

Possible actions:

- Change automatic logout time.
- Read time and date of TROVIS 6610 CPU Module.
- Read web terminal details (browser version, XML version, operating system and network configuration).
- Start **I/O View** web application.

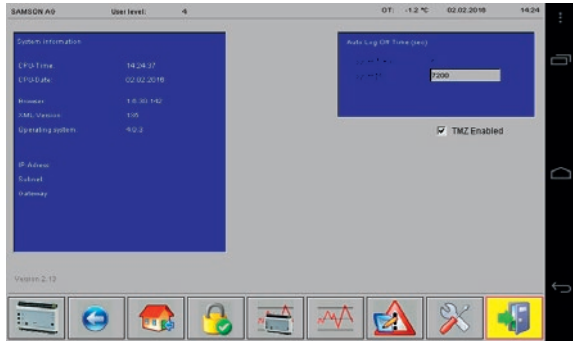



System information		Auto Logout Time (seconds)	
CPU time	14:28:27	Auto Logout Time	7000
CPU date	02.02.2016	TMZ Enabled	<input checked="" type="checkbox"/>
Browser	1.0.30.142		
XML version	1.05		
Operating system	9.0.2		

7.5.1 I/O View web application

The **I/O View** web application enables users to access the input and outputs of the TROVIS 6610 CPU Module and the connected TROVIS 6620 and TROVIS 6625 Modules without the TROVIS 6690 Graphical Project Management Tool. The signal states of the inputs can be read, while the states of the outputs can be also be changed over forced manual operation. This way pumps and control valves can be tested without wiring of the plant.

→ Start or exit **I/O View** web application.

Buttons (toolbar):  / 

7.6 Time program

→ Open time program.

Button: 

Possible actions:

- Add switching times.
- Change switching times.
- Delete switching times.
- Create special schedule.

7.6.1 Adding switching times

1. Select day of the week that you want to configure.

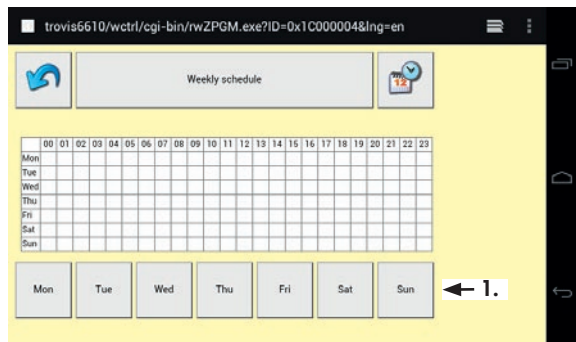

The screenshot shows a web browser window with the URL `trovis6610/wctrl/cgi-bin/rwZPGM.exe?ID=0x1C00004&lng=en`. The page title is "Weekly schedule". It features a grid for scheduling switching times. The grid has 7 rows for days of the week (Mon-Sun) and 24 columns for hours (00-23). Below the grid, there are buttons for each day of the week: Mon, Tue, Wed, Thu, Fri, Sat, and Sun. An arrow labeled "1." points to the "Sun" button.

2. Open configuration of the first switching time with --:-- --:--.

3. Enter start and end times (steps of 15 minutes).

Buttons:  / 

4. Exit configuration.

Button: 



Note:

The configuration can be exited without saving it.

Button: 

The "Entry added" message confirms that the configuration has been saved.

5. Add another switching time, if required.

Button: 

A maximum of 35 switching times per week can be configured.

6. Return to weekly overview.

Button: 

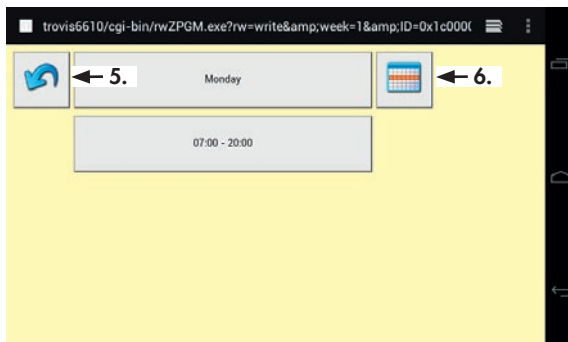
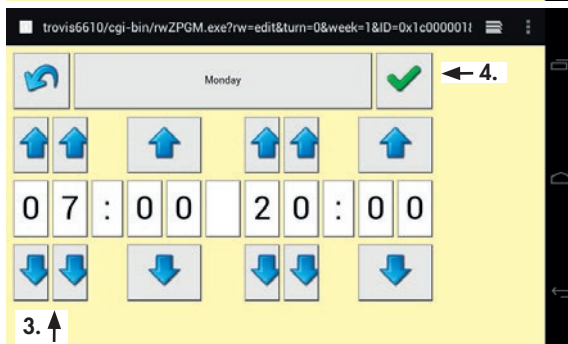
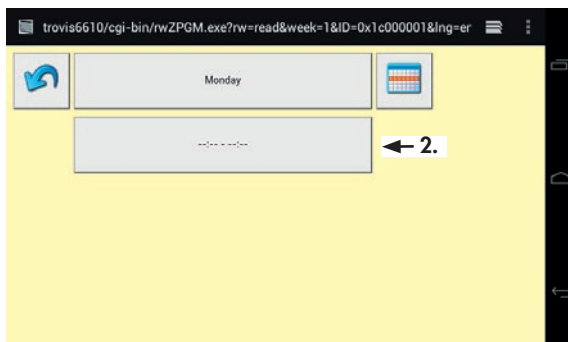

7. Exit time program.

Buttons:  and 



Note:

Exit the time program by pressing  in the Windows version of the MicroBrowser.

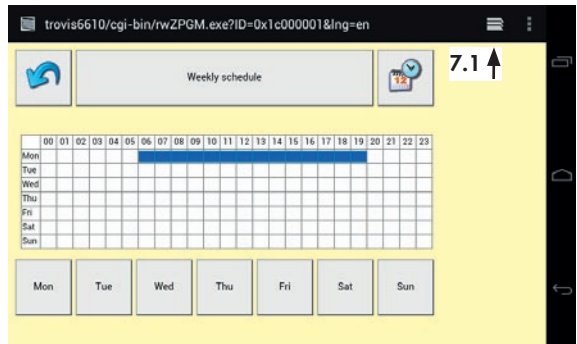

7.6.2 Changing switching times

1. Select day of the week that you want to configure.

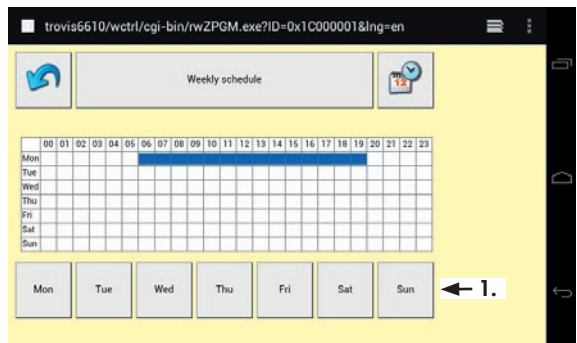

- Open configuration of the switching time you want to change.
- Enter start and end times (steps of 15 minutes).

Buttons:  / 

or:

Delete switching times.
(white buttons between the times)

- Exit configuration.

Button: 



Note:

The configuration can be exited without saving it.

Button: 

The display of the new switching time confirms that the configuration has been saved.

- Return to weekly overview.

Button: 

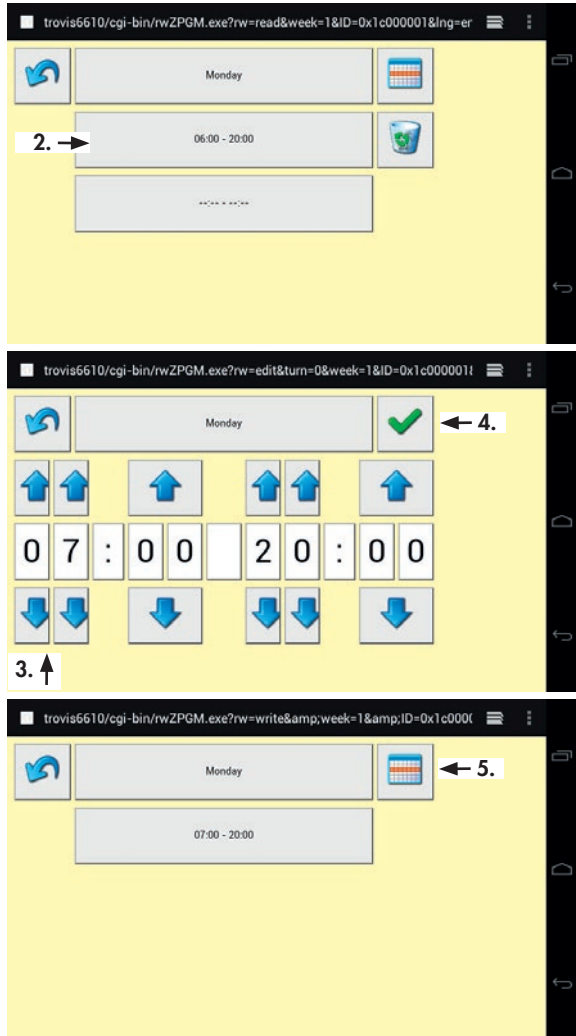

7.6.3 Deleting switching times

1. Select day of the week that you want to configure.
2. Delete switching times.
3. Return to weekly overview.

Button: 

Button: 

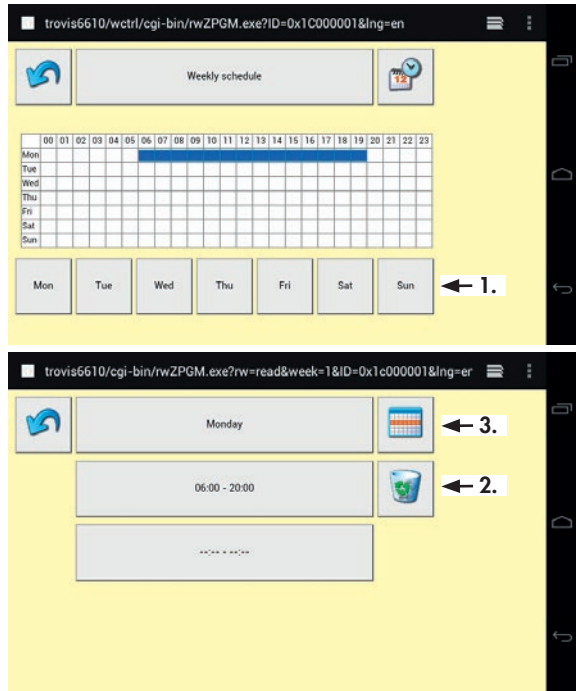

7.6.4 Creating special schedules

Special schedules allow separate switching times to be entered for certain days, for example for vacations or public holidays.

1. Open special schedule.

Button: 

2. Go to configuration of the first special schedule time by selecting ---:--:--:--.

Configuring special schedule (activation)

3. Open the configuration of the start date.

Button: Start ...

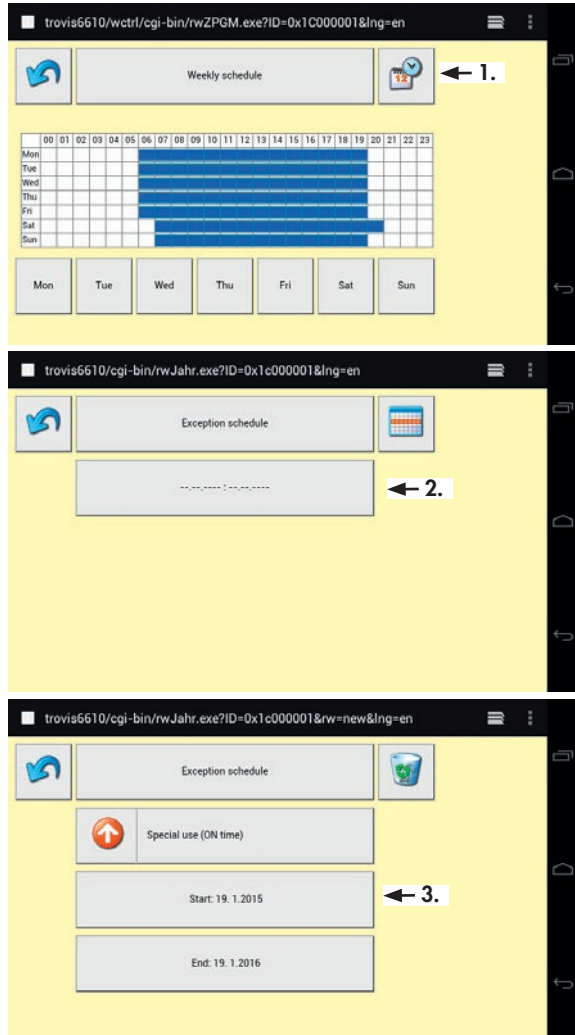

4. Enter start date.

Buttons:  / 

Apply start date on an annual basis, if required.

Button: 

5. Exit configuration.

Button: 



Note:

The configuration can be exited without saving it.

Button: 

The display of the new start date confirms that the configuration has been saved.

6. Enter the end date.

Button: End ...

Enter the end date in the same manner as described for the start date.

7. Exit configuration.

Button: 

The display of the new end date confirms that the configuration has been saved.

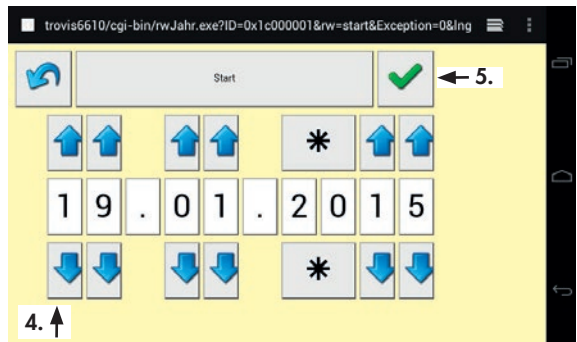
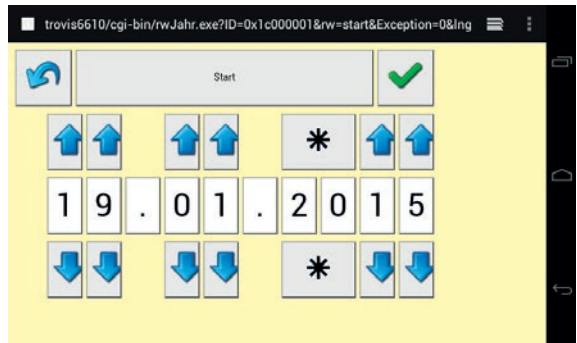

Configuring schedule for vacations or public holidays (deactivation)

8. Change from activation to deactivation.

Button:

[Special schedule (activation)]

Enter the time for deactivation in the same manner as described for activation.

9. Return to weekly overview.

Button:

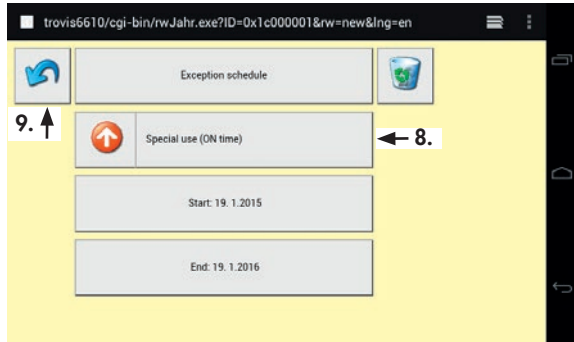

8 TROVIS MOBILE

The TROVIS MOBILE web application can be operated over the browser of the TROVIS 6616 Web Terminal or using a browser in the same network (PC, smartphone). The process view application must be created beforehand in the TROVIS 6690 Graphical Project Management Tool. On transferring the application, the TROVIS MOBILE web application is automatically transferred as well.

TROVIS MOBILE is configured by default as the homepage in the browser at:
<http://trovis6610/ext/panel/index.html>.

1. Start the browser to open TROVIS MOBILE.

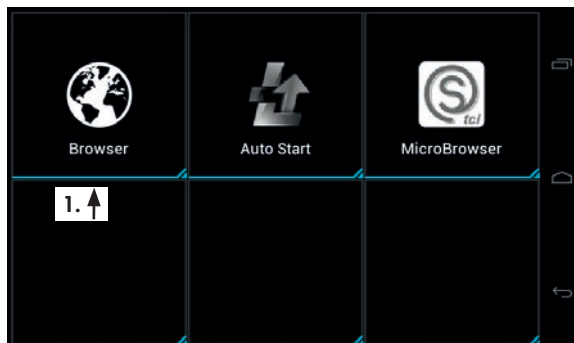

2. Enter the password using the number pad and confirm with [Go].
3. Log in.
Button: [Anmelden]
4. Select [Konfiguration] to change the language.

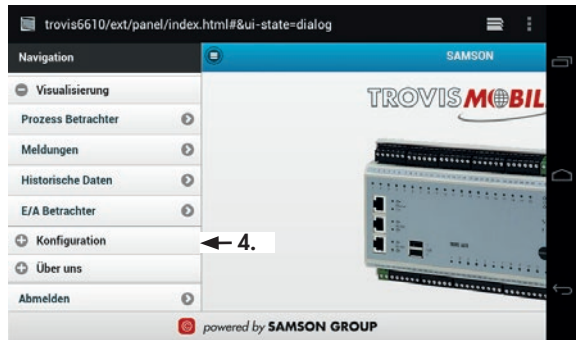
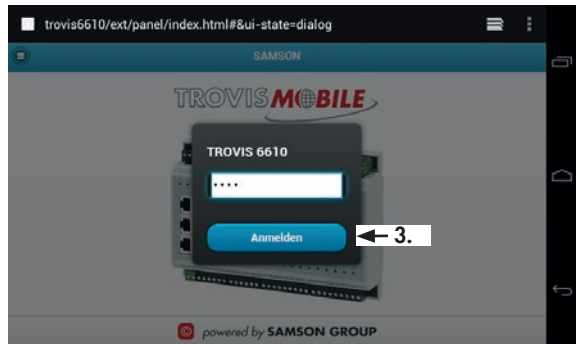
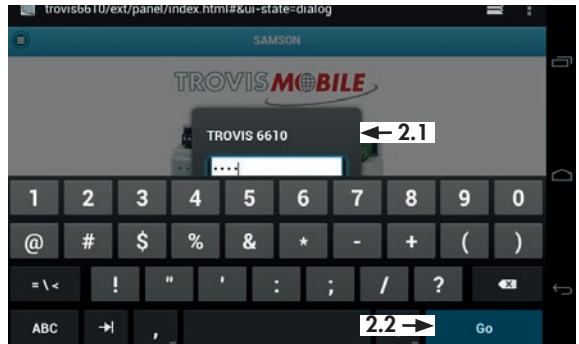

- Open [Sprachauswahl] and select Englisch.

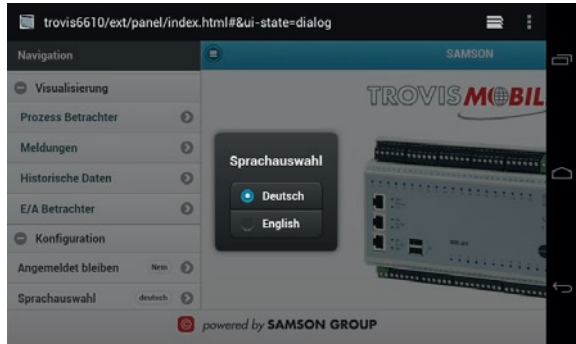

- Confirm message with [OK]. The website is restarted.

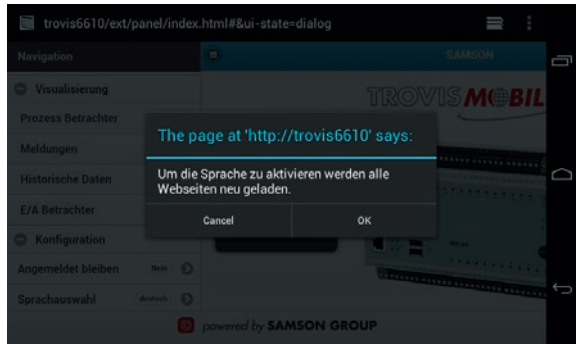

- Reenter password and confirm with [Login].

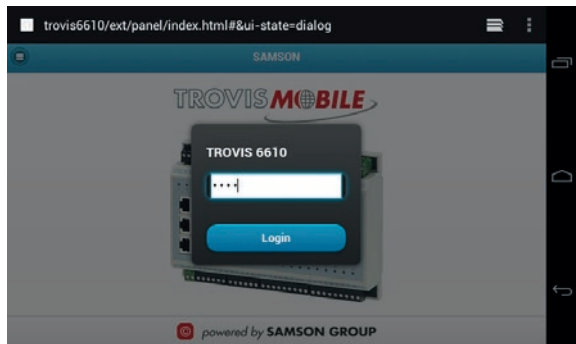

8. In [Process view] go to the required data point.

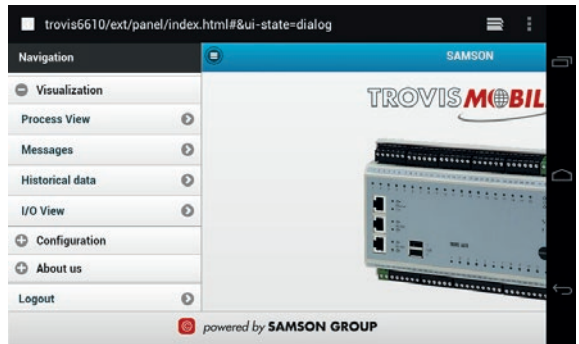

9 Cleaning the screen

1. Open the TouchBlocker on the second page of the Launcher.
A 60-second countdown begins to allow you to clean the screen without it reacting to touch.



Note:

Press  to display the TouchBlocker running in the background.

2. To terminate TouchBlocker, press and swipe it up out of the screen.

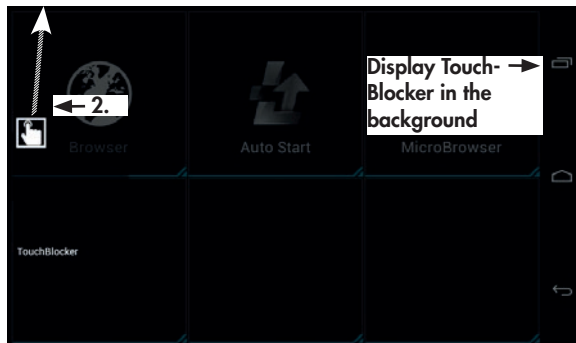
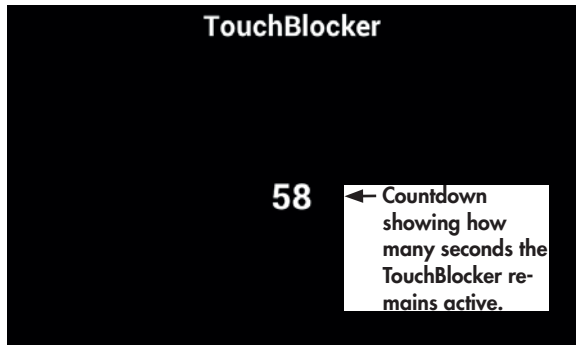
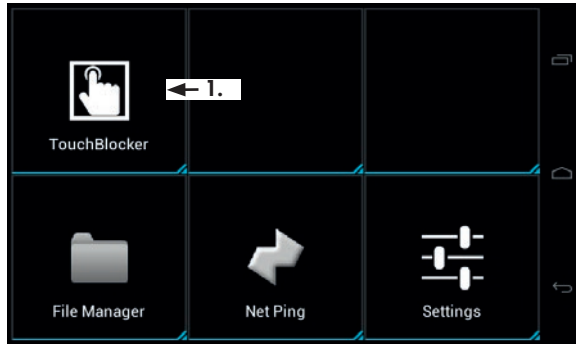

Password

1732



SAMSON AG · MESS- UND REGELTECHNIK
Weismüllerstraße 3 · 60314 Frankfurt am Main, Germany
Phone: +49 69 4009-0 · Fax: +49 69 4009-1507
samson@samson.de · www.samson.de

EB 6616 EN

2016-03-17 · English